

KOSTA BODA
SWEDEN



Kosta är Sveriges äldsta glasbruk.
Det grundades 1742 av två drabanter till Karl XII.
Deras namn var Anders Koskull och
Georg Bogislaus Stael von Holstein.
Sitt namn fick glasbruket av de första
stavelserna i grundarnas efternamn.

Än idag finns hantverket kvar i samma
form som på den gamla tiden.

Kosta är ett av de få glasbruk i världen
där alla glaskonstens hantverksgrenar utövas.

Gamla metoder som slipning, gravering
och etsning blandas med nya modernare.

Allt sedan starten har Kostas historia
varit förknippad med skickliga hantverkare
och talangfulla konstnärer.

I hyttan arbetar mästarna sida vid sida
med formgivarna. Det är detta gemensamma skapande
som gett Kosta dess rykte världen över.
Och som fått inte bara svenska kungar,
utan också statsmän och kungligheter från hela världen
att välja glashantverk från bruket djupt inne
i de småländska skogarna.

Kosta is the oldest glassworks in Sweden.
It was established in 1742 by two officers
of the Life Guard of King Karl XII.

Their names were Anders Koskull and
Georg Bogislaus Stael von Holstein, and the name of the
glassworks consists of the initial syllables of their surnames.

The craftsmanship of two centuries ago lives on
in the same form today.

Kosta is one of the few glassworks in the world
where all the crafts of the glassmaker's art are still practiced.

Older techniques such as grinding, engraving and etching
are combined with new, modern ones.

From the very beginning, glassmaking at Kosta
has been intimately associated with skillful craftsmen
and gifted artists.

Designers and master craftsmen work side by side
in the glasshouse. This joint creativity
has given the Kosta glassworks a world-wide reputation.
And it is the reason why not only the kings of Sweden,
but statesmen and royalty throughout the world
choose glass handicraft from the glassworks
that lies deep in the Swedish forest.

Boda. Förnyelsens glasbruk.

Det startades 1864 av några skickliga glasblåsare på Kosta
som flyttade ut för att bli sina egna herrar.

I nära hundra år var Boda ett bruk bland många
som tillverkade konventionella serviser
för hem och restauranger.

Sedan blåste plötsligt en förnyelsens stormvind
genom bruket.

Unga, djärva formgivare slog till
så att det klirrade i kristallen och Boda förvandlades
med en gång till en fri, frisk experimentverkstad
för nya idéer och nya material.

Nya produkter i färgglada, frestande, köpstimulerande
förpackningar drog i gång en utveckling, som satte spår
i glasförsäljningen över hela världen.

Men fantasin och skaparglädjen har ändå aldrig hindrat
att Boda hela tiden stått stadigt med båda benen på jorden.
Ty visserligen blixtrar idéerna, men de är alltid
tryggt förankrade i enkla mänskliga behov.
Behovet av skönhet. Behovet av funktionella produkter
för hem och hushåll.

Boda. The glassworks that was reborn.

It was established in 1864 by several master glassblowers
from Kosta who wanted to set up on their own.

For about a hundred years, Boda was one glassworks
among many that produced conventional glass services
for use in homes and restaurants.

And then the winds of change blew hard through Boda,
and the glassworks was reborn.

Daring young designers made the crystal ring
and Boda was transformed overnight into a fresh, free
experimental workshop for new ideas and new materials.

New products in colourful, attractive, stimulating packaging
sparked a development that has left its imprint
on glass marketing throughout the world.

But imagination and the joys of creativity have never
prevented Boda from keeping both feet planted solidly on earth.
For the brilliant ideas embodied in Boda glass
are firmly rooted in simple human needs.
The need for beauty. And the need for functional products
for home and household.

Serviser
Glass suites

Serier
Other Glass Ranges

Vaser
Vases

Askfat och skålar
Ashtrays and Bowls

Ljusstakar
Candlesticks

Karaffer och kannor
Decanters and Jugs

Div. glas
Miscellaneous

Kosta Boda Art

**Serviser
Glass suites**

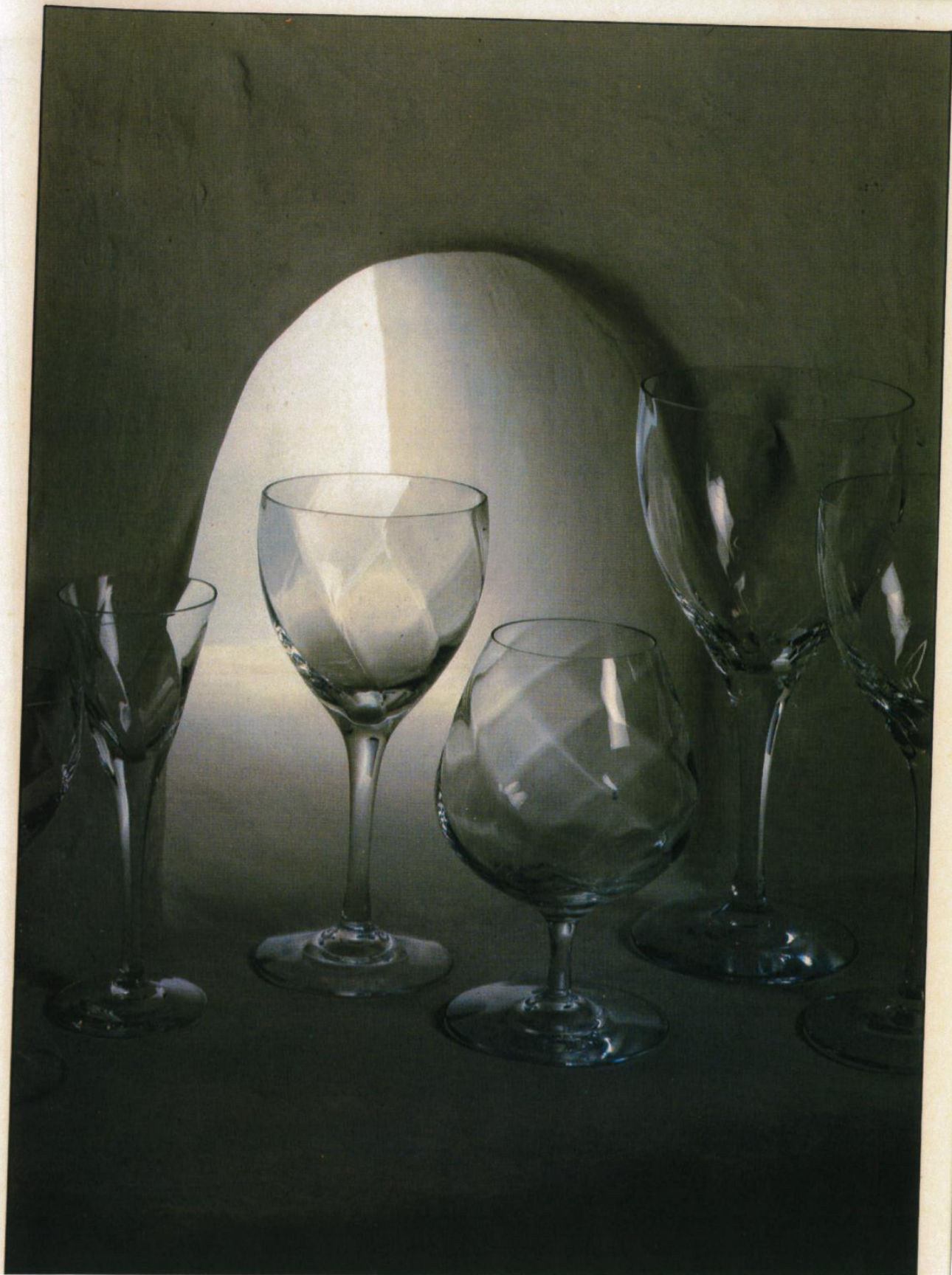

**Design:
Wärff**

Kosta Buster

20286-1
Tumbler 3 cl 4/kart.
Tumbler 1 oz 4/box
H: 51 mm/2"
Ø: 51 mm/2"



20287-1
Cocktail 7 1/2 cl 4/kart.
Cocktail 2 3/5 oz 4/box
H: 67 mm/2 1/2"
Ø: 67 mm/2 1/2"

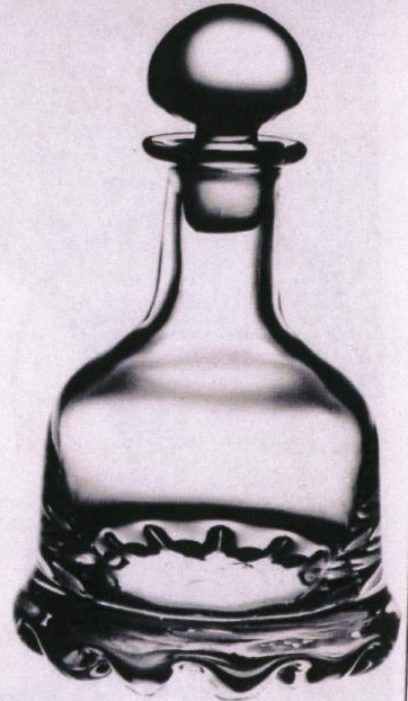

20288-1
O F 15 cl 4/kart.
O F 5 3/10 oz 4/box
H: 75 mm/3"
Ø: 78 mm/3 1/8"



20289-1
D O F 20 cl 4/kart.
D O F 7 oz 4/box
H: 85 mm/3 3/8"
Ø: 85 mm/3 3/8"



20290-1
Tumbler 35 cl 2/kart.
Highball 12 3/10 oz 2/box
H: 140 mm/5 1/2"
Ø: 78 mm/3 1/8"



20279-1
Ishink 85 cl 1/kart.
Icebucket 29 9/10 oz 1/box
H: 123 mm/4 7/8"
Ø: 135 mm/5 3/8"

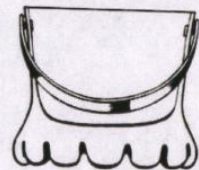



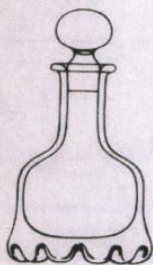



20263-1
Karaff 75 cl
Decanter 24 2/5 oz
H: 255 mm/10"
Ø: 145 mm/5 3/4"

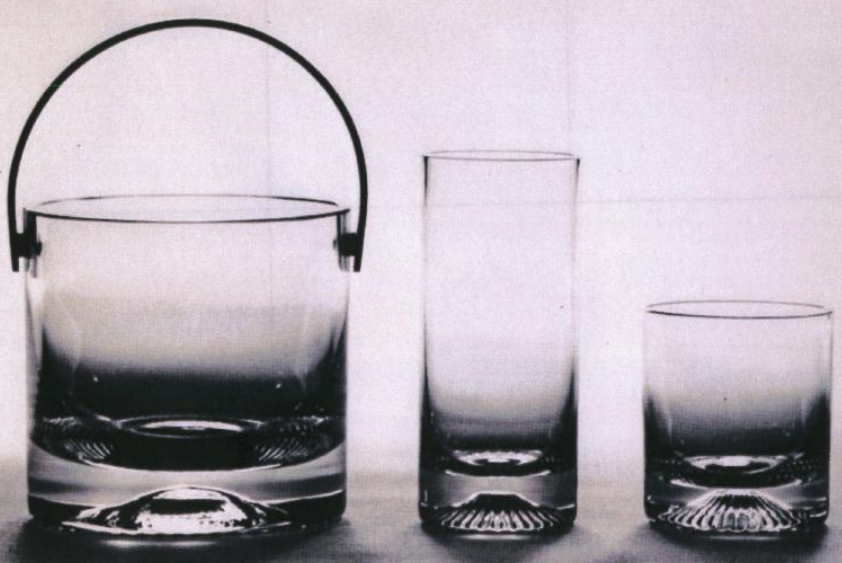
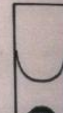

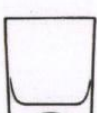
Kosta Calypso

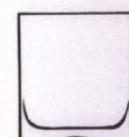
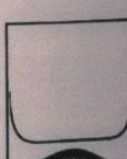
Design:
Vicke Lindstrand

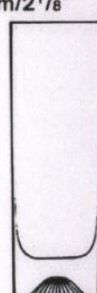
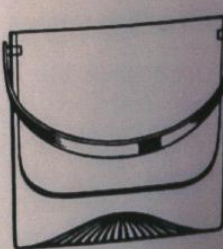
			<p>26501-1 Tumbler 2 1/2 cl Cordial 4/5 oz H: 68 mm/2 3/4" Ø: 33 mm/1 3/8"</p> 
			<p>26525-1 Brännvin 4 cl Snaps 1 2/5 oz H: 80 mm/3 1/8" Ø: 35 mm/1 3/8"</p> 
<p>26552-1 Tumbler 5 cl Tumbler 1 4/5 oz H: 63 mm/2 1/2" Ø: 50 mm/2"</p> 	<p>26551-1 Cocktail 10 cl Cocktail 3 1/2 oz H: 70 mm/2 3/4" Ø: 60 mm/2 3/8"</p> 	<p>26549-1 O F 15 cl O F 5 3/10 oz H: 84 mm/3 3/8" Ø: 66 mm/2 1/2"</p> 	<p>26550-1 D O F 25 cl D O F 8 4/5 oz H: 90 mm/3 1/2" Ø: 80 mm/3 1/8"</p> 
<p>26505-1 Tumbler 15 cl Tumbler 5 3/10 oz H: 125 mm/4 7/8" Ø: 53 mm/2 1/8"</p> 	<p>26548-1 Tumbler 30 cl Highball 10 3/5 oz H: 150 mm/5 7/8" Ø: 68 mm/2 3/4"</p> 	<p>26521-1 Champ. hög 20 cl. Champ. tall 7 oz H: 163 mm/6 1/2" Ø: 54 mm/2 1/8"</p> 	<p>26579-1 Ishink 50 cl 1/kart. Icebucket 17 3/5 oz 1/box H: 110 mm/4 3/8" Ø: 105 mm/4 1/8"</p> 

Design:
Vicke Lindstrand

Kosta Calypso

26581-1
Ishink 85 cl 1/kart.
Icebucket 29⁹/₁₀ oz 1/box
H: 130 mm/5¹/₈"
Ø: 135 mm/5³/₈"

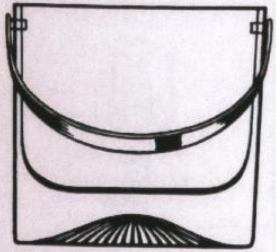

Kosta Carl-Gustav

Crystal

Design:
Sigurd Persson



23003-1
Vin 7¹/₂ cl
Wine 2³/₅ oz
H: 155 mm/6¹/₈"
Ø: 50 mm/2"



23006-1
Vin 20 cl
Wine 7 oz
H: 175 mm/6⁷/₈"
Ø: 65 mm/2¹/₂"



23042-1
Selter 15 cl
Tumbler 5³/₁₀ oz
H: 75 mm/3"
Ø: 75 mm/3"



23025-1
Brännvin
Snaps
H: 150 mm/5⁷/₈"
Ø: 55 mm/2¹/₈"



23021-1
Champ. högt 2/kart.
Champ. tall 2/box
H: 220 mm/8⁵/₈"
Ø: 50 mm/2"



23007-1
Vin 25 cl
Wine 8⁴/₅ oz
H: 195 mm/7⁵/₈"
Ø: 80 mm/3¹/₈"



23062-1
Karaff whisky 75 cl
Decanter whisky 26²/₅ oz
H: 260 mm/10¹/₄"

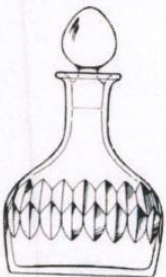

23050-1
DOF 25 cl
DOF 8⁴/₅ oz
H: 85 mm/3³/₈"
Ø: 85 mm/3³/₈"



23049-1
Cocktail
Cocktail
H: 70 mm/2³/₄"
Ø: 70 mm/2³/₄"



23046-1
Grogg 35 cl
Highball 12³/₁₀ oz
H: 140 mm/5¹/₂"
Ø: 75 mm/3"



Crystal

**Design:
Sigurd Persson**

Kosta Carl-Gustav

23063-1
Karaff vin 75 cl
Decanter wine 26²/₅ oz
H: 290 mm/11³/₈"





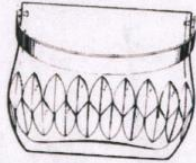



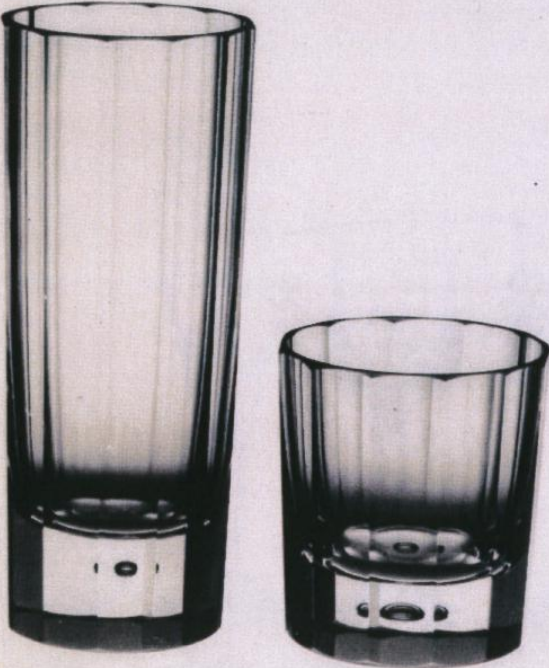

23079-1
Ishink
Icebucket
H: 125 mm/4⁷/₈"
Ø: 155 mm/6¹/₈"



Kosta Drottningholm

Crystal

	<p>21301-1 Brännvin Snaps H: 80 mm/3¹/₈" Ø: 32 mm/1¹/₈"</p> 	<p>21349-1 O F 15 cl O F 5³/₁₀ oz H: 80 mm/3¹/₈" Ø: 70 mm/2³/₄"</p> 
	<p>21351-1 Cocktail 7¹/₂ cl Cocktail 2³/₅ oz H: 70 mm/2³/₄" Ø: 60 mm/2³/₈"</p> 	<p>21350-1 D O F 20 cl D O F 7 oz H: 90 mm/3¹/₂" Ø: 78 mm/3¹/₈"</p> 
	<p>21305-1 Tumbler 15 cl Tumbler 5³/₁₀ oz H: 130 mm/5¹/₈" Ø: 55 mm/2¹/₈"</p> 	<p>21346-1 Tumbler 35 cl Highball 12³/₁₀ oz H: 170 mm/6³/₄" Ø: 66 mm/2¹/₂"</p> 
		

Crystal

**Design:
Sigurd Persson**

Kosta Gripsholm

22225-1
Brännvin 5 cl
Snaps 1⁴/₅ oz
H: 154 mm/6¹/₈"
Ø: 67 mm/2¹/₂"



22293-1
Vin 7¹/₂ cl 2/kart.
Wine 2³/₅ oz 2/box
H: 134 mm/5³/₈"
Ø: 55 mm/2¹/₈"



22204-1
Vin 10 cl
Wine 3¹/₂ oz
H: 150 mm/5⁷/₈"
Ø: 65 mm/2¹/₂"



22294-1
Vin 20 cl 2/kart.
Wine 7 oz 2/box
H: 157 mm/6¹/₈"
Ø: 73 mm/3"



22208-1
Vin 30 cl
Wine 10³/₅ oz
H: 172 mm/6⁵/₈"
Ø: 76 mm/3"



22221-1
Champagne högt 2/kart.
Champagne high 2/box
H: 215 mm/8¹/₂"



22222-1
Champ.skål 30 cl
Champ.bowl 10³/₅ oz
H: 146 mm/5³/₄"
Ø: 95 mm/3³/₄"



22242-1
Tumbler 15 cl
Tumbler 5³/₁₀ oz
H: 70 mm/2³/₄"
Ø: 57 mm/2¹/₈"

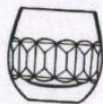

22290-1
Tumbler 35 cl 2/kart.
Tumbler 12³/₁₀ oz 2/box
H: 120 mm/4³/₄"
Ø: 62 mm/2³/₈"

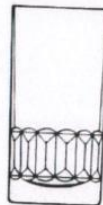

Kosta Karlberg

Crystal



22523-1
 Madeiraskål
 Madeirabowl
 H: 80 mm/3¹/₈"
 Ø: 65 mm/2¹/₂"



22525-1
 Brännvin
 Snaps
 H: 95 mm/3³/₄"
 Ø: 45 mm/1³/₄"



22501-1
 Vin 2¹/₂ cl
 Wine 4¹/₅ oz
 H: 85 mm/3³/₈"
 Ø: 35 mm/1³/₈"



22503-1
 Vin 7¹/₂ cl
 Wine 2³/₅ oz
 H: 95 mm/3³/₄"
 Ø: 50 mm/2"



22505-1
 Vin 15 cl
 Wine 5³/₁₀ oz
 H: 115 mm/4¹/₂"
 Ø: 70 mm/2³/₄"



22506-1
 Vin 20 cl
 Wine 7 oz
 H: 130 mm/5¹/₈"
 Ø: 70 mm/2³/₄"



22507-1
 Vin 25 cl
 Wine 8⁴/₅ oz
 H: 135 mm/5³/₈"
 Ø: 75 mm/3"

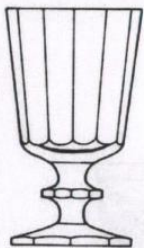

22521-1
 Champ. högt
 Champ. tall
 H: 160 mm/6¹/₄"
 Ø: 55 mm/2¹/₈"

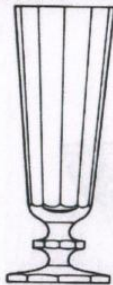

90088-1
 Tumbler 15 cl
 Tumbler 5³/₁₀ oz
 H: 75 mm/3"
 Ø: 60 mm/2³/₈"



22542-1
 Tumbler 15 cl
 Tumbler 5³/₁₀ oz
 H: 80 mm/3¹/₈"
 Ø: 55 mm/2¹/₈"



Crystal

Kosta Elvira Madigan

29224-1
Likörskål
Liquerbowl
H: 90 mm/3 1/2"
Ø: 80 mm/3 1/8"



29223-1
Madeiraskål
Madeirabowl
H: 100 mm/4"
Ø: 75 mm/3"



29225-1
Brännvin
Snaps
H: 105 mm/4 1/8"
Ø: 50 mm/2"



29203-1
Vin 7 1/2 cl
Wine 2 3/5 oz
H: 115 mm/4 1/2"
Ø: 55 mm/2 1/8"



29204-1
Vin 10 cl
Wine 3 1/2 oz
H: 125 mm/4 7/8"
Ø: 65 mm/2 1/2"



29205-1
Vin 15 cl
Wine 5 3/10 oz
H: 140 mm/5 1/2"
Ø: 70 mm/2 3/4"



29207-1
Vin 25 cl
Wine 8 4/5 oz
H: 160 mm/6 1/4"
Ø: 80 mm/3 1/8"



29221-1
Champ. högt
Champ. tall
H: 170 mm/6 3/4"
Ø: 60 mm/2 3/8"



29222-1
Champ.skål
Champ. bowl
H: 115 mm/4 1/2"
Ø: 100 mm/4"







29242-1
Tumbler 15 cl
Tumbler 5 3/10 oz
H: 80 mm/3 1/8"
Ø: 70 mm/2 3/4"



Kosta Elvira Madigan

29263-1
Karaff 80 cl
Decanter 28¹/₅ oz
H: 320 mm/12¹/₂"



Design:
Vicke Lindstrand

Kosta Mambo

23589-1

Tumbler 3 1/2 cl 4/kart
Tumbler 1 1/4 oz 4/box
H: 75 mm/3"
Ø: 40 mm/1 1/2"

23513-1

Tumbler 3 1/2 cl/ej fp
Tumbler 1 1/4 oz/not boxed



23590-1

Vin 7 1/2 cl 4/kart.
Wine 2 3/5 oz 4/box
H: 90 mm/3 1/2"
Ø: 50 mm/2"

23503-1

Vin 7 1/2 cl/ej fp
Wine 2 3/5 oz/not boxed



23591-1

Vin 15 cl 4/kart.
Wine 5 3/10 oz 4/box
H: 105 mm/4 1/8"
Ø: 62 mm/2 3/8"

23505-1

Vin 15 cl/ej fp
Wine 5 3/10 oz/not boxed

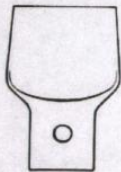

23592-1

Vin 20 cl 4/kart.
Wine 7 oz 4/box
H: 115 mm/4 1/2"
Ø: 72 mm/2 3/4"

23506-1

Vin 20 cl/ej fp
Wine 7 oz/not boxed

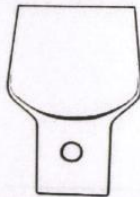

23593-1

Vin 25 cl 4/kart.
Wine 8 4/5 oz 4/box
H: 120 mm/4 3/4"
Ø: 82 mm/3 1/8"

23507-1

Vin 25 cl/ej fp
Wine 8 4/5 oz/not boxed

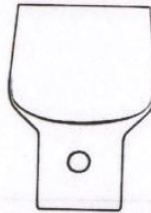

23594-1







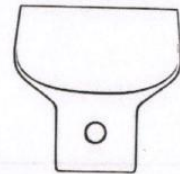

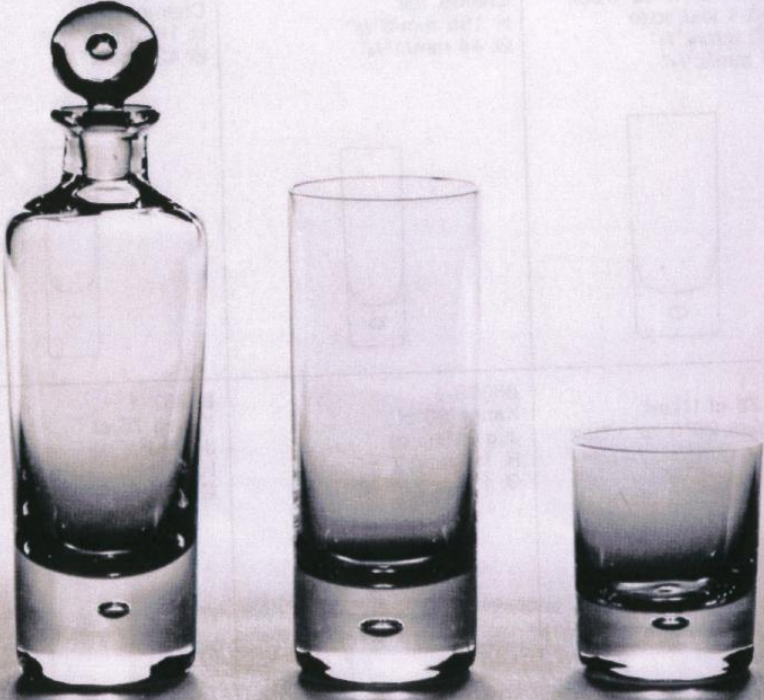
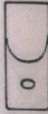

Dessertsål 25 cl 4/kart.
Dessert bowl 8 4/5 oz 4/box
H: 100 mm/4"
Ø: 98 mm/3 7/8"

23522-1











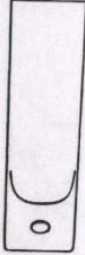
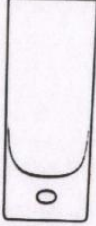

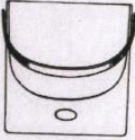
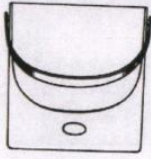
Dessertsål 25 cl/ej fp
Dessert bowl 8 4/5 oz/not boxed

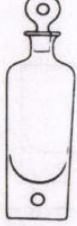

Kosta Pippi

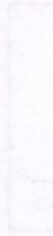
			<p>29891-1 Brännvin 3 cl 4/kart. Snaps 1 oz 4/box 29801-1 lös/loose H: 85 mm/3³/₈" Ø: 35 mm/1³/₈"</p> 
			<p>29892-1 Brännvin 5 cl 4/kart. Snaps 1⁴/₅ oz 4/box 29825-1 lös/loose H: 120 mm/4³/₄" Ø: 40 mm/1¹/₂"</p> 
<p>29826-1 Cocktail 10 cl Cocktail 3¹/₂ oz H: 70 mm/2³/₄" Ø: 60 mm/2³/₈"</p> 	<p>29849-1 O F 15 cl O F 5³/₁₀ oz H: 80 mm/3¹/₈" Ø: 70 mm/2³/₄"</p> 	<p>29893-1 D O F 4/kart. D O F 4/box 29850-1 lös/loose H: 90 mm/3¹/₂" Ø: 80 mm/3¹/₈"</p> 	<p>29852-1 Tumbler 5 cl Tumbler 1⁴/₅ oz H: 62 mm/2³/₈" Ø: 50 mm/2"</p> 
<p>29842-1 Tumbler 10 cl Tumbler 3¹/₂ oz H: 110 mm/4³/₈" Ø: 53 mm/2¹/₈"</p> 	<p>29805-1 Tumbler 15 cl Tumbler 5³/₁₀ oz H: 130 mm/5¹/₈" Ø: 55 mm/2¹/₈"</p> 	<p>29894-1 Tumbler 25 cl 4/kart. Tumbler 8⁴/₅ oz 4/box 29844-1 lös/loose H: 175 mm/6⁷/₈" Ø: 55 mm/2¹/₈"</p> 	<p>29896-1 Tumbler 30 cl 4/kart. Tumbler 10³/₅ oz 4/box 29847-1 Tumbler lös/loose H: 95 mm/3³/₄" Ø: 90 mm/3¹/₂"</p> 

Kosta Pippi

<p>29845-1 Tumbler 30 cl Tumbler 10³/₅ oz H: 193 mm/7⁵/₈" Ø: 55 mm/2¹/₈"</p> 	<p>29895-1 Tumbler 35 cl 4/kart. Tumbler 12³/₁₀ oz 4/box 29846-1 lös/loose H: 160 mm/6¹/₄" Ø: 70 mm/2³/₄"</p> 	<p>29821-1 Champ. högt Champ. tall H: 155 mm/6¹/₈" Ø: 44 mm/1³/₄"</p> 	<p>29831-1 Champ. stort Champ. large H: 192 mm/7¹/₂" Ø: 43 mm/1³/₄"</p> 
<p>29879-1 Ishink 50 cl 1/kart. Icebucket 17³/₅ oz 1/box H: 110 mm/4³/₈" Ø: 105 mm/4¹/₈"</p> 	<p>29881-1 Ishink 75 cl 1/kart. Icebucket 26²/₅ oz 1/box H: 127 mm/4⁷/₈" Ø: 130 mm/5¹/₈"</p> 	<p>86398-1 Kanna 90 cl Jug 31⁷/₁₀ oz H: 190 mm/7¹/₂" Ø: 115 mm/4¹/₂"</p> 	<p>86397-1 Kanna 75 cl Jug 26²/₅ oz H: 260 mm/10¹/₄" Ø: 85 mm/3³/₈"</p> 
<p>86399-1 Karaff 75 cl Decanter 26²/₅ oz H: 235 mm/9¹/₄" Ø: 120 mm/4³/₄"</p> 	<p>29861-1 Karaff 32 cl Decanter 11³/₁₀ oz H: 250 mm/9⁷/₈" Ø: 75 mm/3"</p> 	<p>87614-1 Karaff 75 cl Decanter 26²/₅ oz H: 290 mm/11³/₈"</p> 	<p>29862-1 Karaff 60 cl Decanter 21¹/₁₀ oz H: 320 mm/12¹/₂" Ø: 80 mm/3¹/₈"</p> 
			

Kosta Prince

Crystal

Design:
Wärff



29024-1
Likörskål 3 cl
Liqueurbowl 1 oz
H: 95 mm/3³/₄"
Ø: 60 mm/2³/₈"



29025-1
Brännvin 3 cl
Snaps 1 oz
H: 135 mm/5³/₈"
Ø: 50 mm/2"



29001-1
Vin 2¹/₂ cl
Wine 4¹/₅ oz
H: 105 mm/4¹/₈"
Ø: 47 mm/1³/₄"



29090-1
Vin 7¹/₂ cl 2/kart.
Wine 2³/₅ oz 2/box
H: 120 mm/4³/₄"
Ø: 58 mm/2³/₄"



29004-1
Vin 10 cl
Wine 3¹/₂ oz
H: 138 mm/5¹/₂"
Ø: 67 mm/2¹/₂"



29091-1
Vin 15 cl 2/kart.
Wine 5³/₁₀ oz 2/box
H: 155 mm/6¹/₈"
Ø: 78 mm/3¹/₈"



29007-1
Vin 25 cl
Wine 8⁴/₅ oz
H: 170 mm/6⁵/₈"
Ø: 85 mm/3³/₈"



29021-1
Champ. högt 16 cl
Champ. tall 5³/₅ oz
H: 220 mm/8⁵/₈"
Ø: 85 mm/3³/₈"



29022-1
Champ.skål 18 cl
Champ.bowl 6³/₁₀ oz
H: 120 mm/4³/₄"
Ø: 103 mm/4¹/₈"



29075-1
Punsch 7¹/₂ cl 2/kart.
Punsch 2³/₅ oz 2/box
H: 50 mm/2"
Ø: 58 mm/2³/₈"



Kosta Prince

Crystal

Design:
Wärff



29024-1
Likörskål 3 cl
Liqueurbowl 1 oz
H: 95 mm/3³/₄"
Ø: 60 mm/2³/₈"



29025-1
Brännvin 3 cl
Snaps 1 oz
H: 135 mm/5³/₈"
Ø: 50 mm/2"



29001-1
Vin 2¹/₂ cl
Wine 4¹/₅ oz
H: 105 mm/4¹/₈"
Ø: 47 mm/1³/₄"



29090-1
Vin 7¹/₂ cl 2/kart.
Wine 2³/₅ oz 2/box
H: 120 mm/4³/₄"
Ø: 58 mm/2³/₄"



29004-1
Vin 10 cl
Wine 3¹/₂ oz
H: 138 mm/5¹/₂"
Ø: 67 mm/2¹/₂"



29091-1
Vin 15 cl 2/kart.
Wine 5³/₁₀ oz 2/box
H: 155 mm/6¹/₈"
Ø: 78 mm/3¹/₈"



29007-1
Vin 25 cl
Wine 8⁴/₅ oz
H: 170 mm/6⁵/₈"
Ø: 85 mm/3³/₈"



29021-1
Champ. högt 16 cl
Champ. tall 5³/₅ oz
H: 220 mm/8⁵/₈"
Ø: 85 mm/3³/₈"

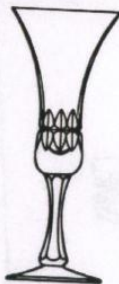

29022-1
Champ.skål 18 cl
Champ.bowl 6³/₁₀ oz
H: 120 mm/4³/₄"
Ø: 103 mm/4¹/₈"



29075-1
Punsch 7¹/₂ cl 2/kart.
Punsch 2³/₅ oz 2/box
H: 50 mm/2"
Ø: 58 mm/2³/₈"



Crystal

**Design:
Wärff**

Kosta Prince

29052-1
Tumbler 10 cl
Tumbler 3 1/2 oz
H: 65 mm/2 1/2"
Ø: 62 mm/2 3/8"



29095-1
Cocktail 15 cl 2/kart.
Cocktail 5 3/10 oz 2/box
H: 70 mm/2 3/4"
Ø: 70 mm/2 3/4"



29093-1
O F 20 cl 2/kart.
O F 7 oz 2/box
H: 84 mm/3 3/8"
Ø: 84mm/3 3/8"



29094-1
D O F 2/kart.
D O F 2/box
H: 100 mm/4"
Ø: 95 mm/3 3/4"



29048-1
Tumbler 35 cl
Highball 12 3/10 oz
H: 114 mm/4 1/2"
Ø: 87 mm/3 3/8"



29096-1
Tumbler 35 cl 2/kart.
Tumbler 12 3/10 oz 2/box
H: 148 mm/5 7/8"
Ø: 79 mm/3 1/8"



29079-1
Ishink 50 cl
Icebucket 17 3/5 oz
H: 108 mm/4 3/8"
Ø: 115 mm/4 1/2"

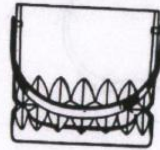

29062-1
Karaff 65 cl 1/kart.
Decanter 22 9/10 oz 1/box
H: 220 mm/8 5/8"
Ø: 70 mm/2 3/4"



86200-1
Karaff 50 cl 1/kart.
Decanter 17 3/5 oz 1/box
H: 235 mm/9 1/4"

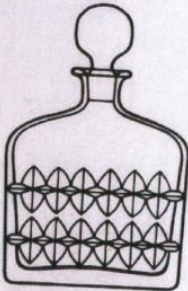







86207-1
Karaff 65 cl
Decanter 22 9/10 oz
H: 230 mm/9"
Ø: 125 mm/4 7/8"



Kosta Rondo

Design:
Wärff

<p>26091-1 Cognac 15 cl Brandy 5³/₁₀ oz H: 100 mm/4" Ø: 50 mm/2"</p> 	<p>26092-1 Cognac 20 cl 4/kart. Brandy 7 oz 4/box H: 110 mm/4³/₈" Ø: 55 mm/2¹/₈"</p> 	<p>26093-1 Cognac 30 cl Brandy 10³/₅ oz H: 120 mm/4³/₄" Ø: 65 mm/2¹/₂"</p> 	<p>26081-1 Ishink 1/kart. Icebucket 1/box H: 120 mm/4³/₄" Ø: 130 mm/5¹/₈"</p> 
<p>26062-1 Karaff 80 cl Decanter 28¹/₅ oz H: 240 mm/9¹/₂"</p> 	<p>26063-1 Karaff 150 cl Decanter 52⁴/₅ oz H: 300 mm/11³/₄"</p> 		

**Design:
Wärrf**

Kosta Rurik

26280-1
Whisky 8 cl 4/kart.
Whisky 2⁴/₅ oz 4/box
H: 55 mm/2¹/₈"
Ø: 46 mm/1³/₄"



26281-1
Cocktail 15 cl 4/kart.
Cocktail 5³/₁₀ oz 4/box
H: 70 mm/2³/₄"
Ø: 65 mm/2¹/₂"



26282-1
O F 20 cl 4/kart.
O F 7 oz 4/box
H: 76 mm/3"
Ø: 73 mm/2⁷/₈"



26283-1
D O F 25 cl 4/kart.
D O F 8⁴/₅ oz 4/box
H: 90 mm/3¹/₂"
Ø: 85 mm/3³/₈"



26284-1
Tumbler 45 cl 4/kart.
Tumbler 15⁴/₅ oz 4/box
H: 145 mm/5³/₄"
Ø: 70 mm/2³/₄"

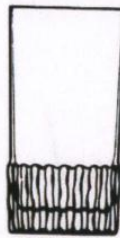

26262-1
Karaff 60 cl
Decanter 21¹/₁₀ oz
H: 235 mm/9¹/₄"
Ø: 83 mm/3¹/₄"



26279-1
Ishink 1/kart.
Icebucket 1/box
H: 120 mm/4³/₄"
Ø: 128 mm/5"

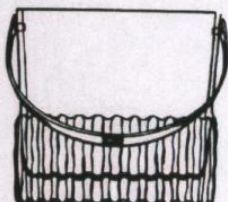

Boda Admiral

Design:
Bertil Vallien



20125-3
Brännvin 2 1/2 cl 2/kart.
Snaps 4/5 oz 2/box
H: 80 mm/3 1/8"
Ø: 45 mm/1 3/4"



20151-3
Cocktail 10 cl 2/kart.
Cocktail 3 1/2 oz 2/box
H: 70 mm/2 3/4"
Ø: 75 mm/3"



20149-3
Tumbler O F 15 cl 2/kart.
Tumbler O F 5 3/10 oz 2/box
H: 80 mm/3 1/8"
Ø: 85 mm/3 3/8"



20150-3
Tumbler D O F 22 cl 2/kart.
Tumbler D O F 7 7/10 oz 2/box
H: 85 mm/3 3/8"
Ø: 90 mm/3 1/2"



20146-3
Grogg 35 cl 2/kart.
Highball 12 3/10 oz 2/box
H: 140 mm/5 1/2"
Ø: 80 mm/3 1/8"



20162-3
Karaff 50 cl 1/kart.
Decanter 17 3/5 oz 1/box
H: 255 mm/10"

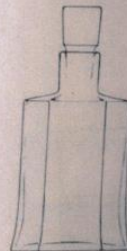

20169-3
Shaker 1/kart.
Shaker 1/box
H: 290 mm/11 3/8"

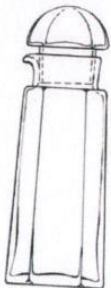

20179-3
Ishink 120 cl 1/kart.
Icebucket 42 1/5 oz 1/box
H: 150 mm/5 7/8"
Ø: 145 mm/5 3/4"



48178-3
Orkidévas 1/kart.
Bud vase 1/box
H: 230 mm/9"



Design:
Arne Branzell

Boda Ann

20804-4
Vin 10 cl
Wine 3 oz
H: 135 mm/5³/₈"
Ø: 70 mm/2³/₄"



20805-4
Vin 15 cl
Wine 5 oz
H: 150 mm/5⁷/₈"
Ø: 75 mm/3"



20806-4
Vin 22 cl
Wine 7¹/₂ oz
H: 165 mm/6¹/₂"
Ø: 80 mm/3¹/₈"



20808-4
Vin 30 cl
Wine 10 oz
H: 180 mm/7¹/₈"
Ø: 90 mm/3¹/₂"



20809-4
Vin 35 cl
Wine 12 oz
H: 200 mm/7⁷/₈"
Ø: 100 mm/4"



20821-4
Champ. högt 20 cl
Champ. tall 7 oz
H: 215 mm/8¹/₂"
Ø: 70 mm/2³/₄"



20822-4
Champ.skål 22 cl
Champ.bowl 7¹/₂ oz
H: 140 mm/5¹/₂"
Ø: 100 mm/4"



20831-4
Champagne hög
Champagne tall
H: 220 mm/8⁵/₈"
Ø: 52 mm/2"



20825-4
Brännvin
Snaps
H: 135 mm/5³/₈"
Ø: 50 mm/2"



20842-4
Selter 15 cl
Tumbler 5³/₁₀ oz
H: 90 mm/3¹/₂"
Ø: 63 mm/2¹/₂"











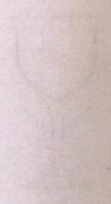
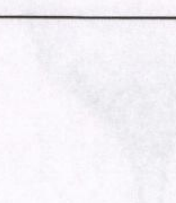
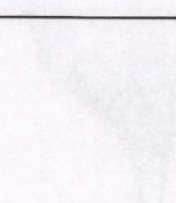
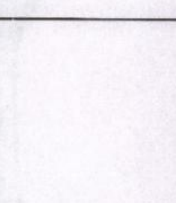

Boda Ann

Design:
Arne Branzell

97917-4
Aromkupa 2/kart.
Brandy 2/box
H: 135 mm/5³/₈"
Ø: 65 mm/2¹/₂"

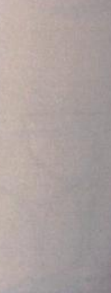

<p>97917-4 Aromkupa 2/kart. Brandy 2/box H: 135 mm/5³/₈" Ø: 65 mm/2¹/₂"</p> 			
			
			
			

Design:
Bertil Vallien

Boda Ballad

26725-3
Brännvin 5 cl 2/kart.
Snaps 1⁴/₅ oz 2/box
H: 85 mm/3³/₈"
Ø: 45 mm/1³/₄"



26703-3
Vin 7¹/₂ cl 2/kart.
Wine 2³/₅ oz 2/box
H: 115 mm/4¹/₂"
Ø: 65 mm/2¹/₂"

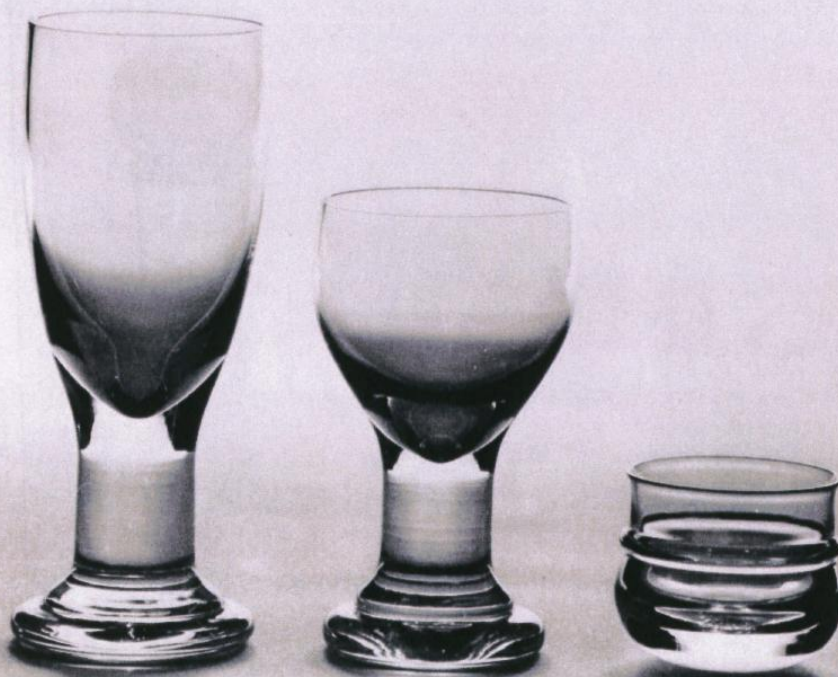

26704-3
Vin 10 cl 2/kart.
Wine 3¹/₂ oz 2/box
H: 135 mm/5³/₈"
Ø: 73 mm/3"



26705-3
Vin 15 cl 2/kart.
Wine 5³/₁₀ oz 2/box
H: 155 mm/6¹/₈"
Ø: 84 mm/3³/₈"



26707-3
Vin 25 cl 2/kart.
Wine 8⁴/₅ oz 2/box
H: 167 mm/6¹/₂"
Ø: 90 mm/3¹/₂"



26716-3
Öl 40 cl 2/kart.
Beer 14¹/₁₀ oz 2/box
H: 210 mm/8¹/₄"
Ø: 75 mm/3"



26751-3
Cocktail 10 cl 4/kart.
Cocktail 3¹/₂ oz 4/box
H: 60 mm/2³/₈"
Ø: 70 mm/2³/₄"



26735-3
Dessertsål 2/kart.
Dessert bowl 2/box
H: 105 mm/4¹/₈"



Boda Bouquet

Design:
Signe Persson-Melin

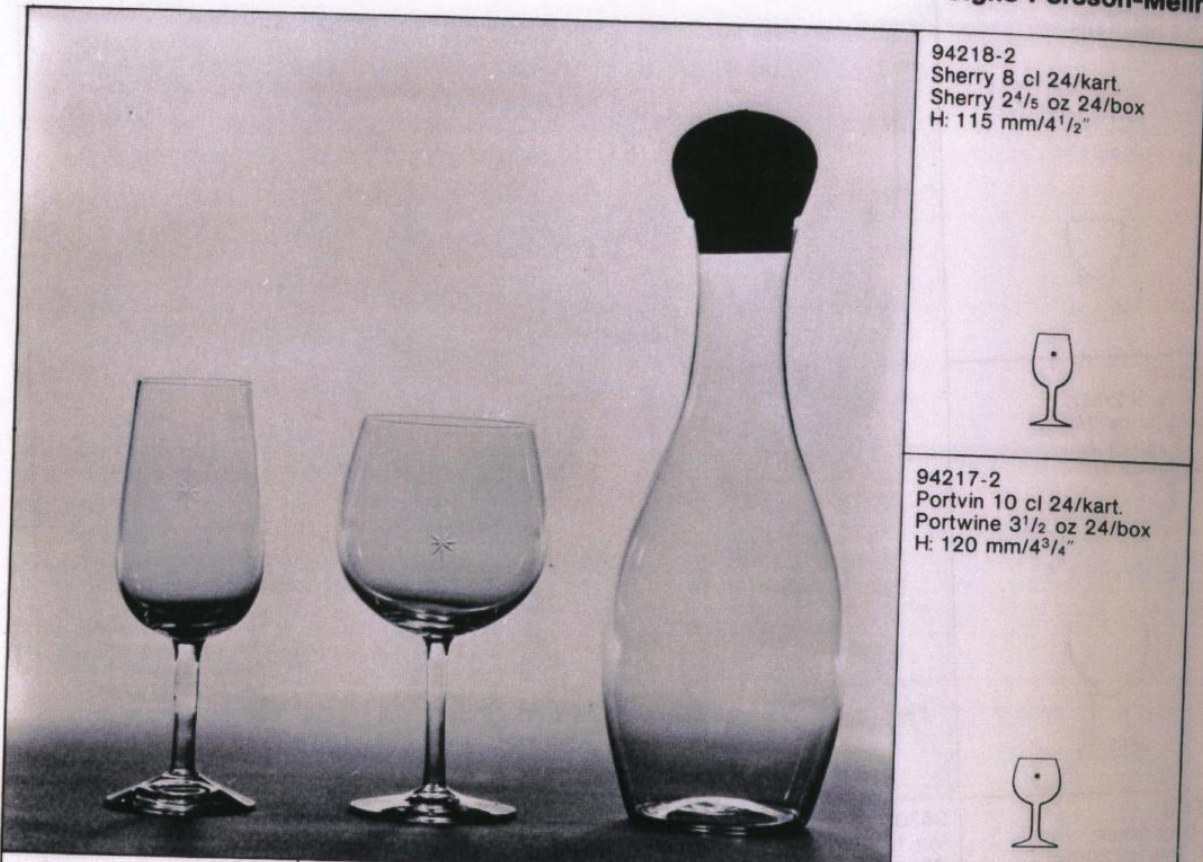

94218-2
Sherry 8 cl 24/kart.
Sherry 2⁴/₅ oz 24/box
H: 115 mm/4¹/₂"



94217-2
Portvin 10 cl 24/kart.
Portwine 3¹/₂ oz 24/box
H: 120 mm/4³/₄"



94206-2
Vittvinsglas 20 cl 24/kart.
White Wine glass 7 oz
24/box
H: 175 mm/6⁷/₈"



94207-2
Rödvinsglas 35 cl 24/kart.
Red Wine glass 12³/₁₀ oz
24/box
H: 160 mm/6¹/₄"



94199-2
Karaff 100 cl 1/kart.
Decanter 35¹/₁₀ oz 1/box
H: 295 mm/11⁵/₈"



Design:
Bertil Vallien

Boda Château

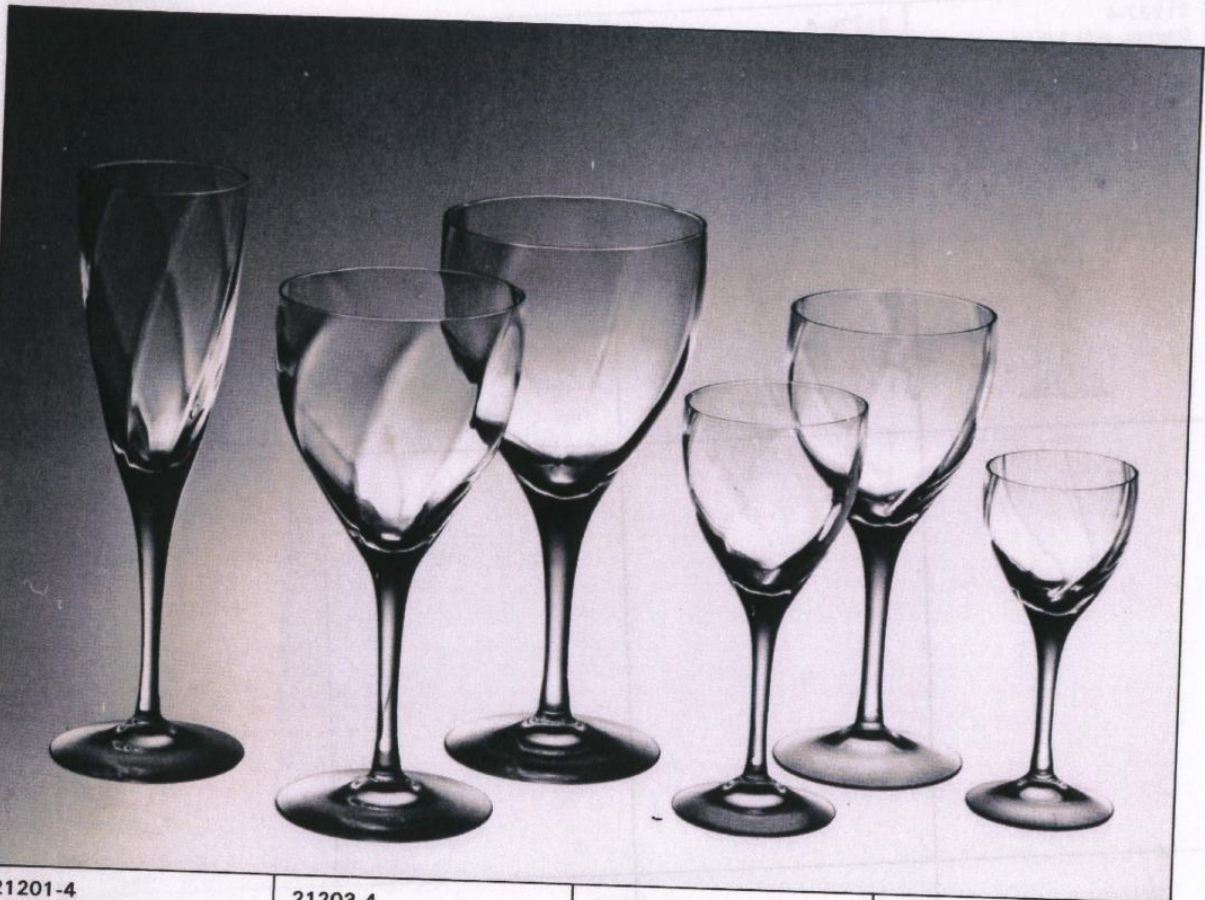

21201-4
Vinglas 4 cl 2/kart.
Wine 1 3/5 oz 2/box
H: 120 mm/4 3/4"
Ø: 50 mm/2"



21203-4
Vinglas 7 1/2 cl 2/kart.
Wine 2 3/5 oz 2/box
H: 145 mm/5 3/4"
Ø: 60 mm/2 3/8"



21204-4
Vinglas 10 cl 2/kart.
Wine 3 1/2 oz 2/box
H: 155 mm/6 1/8"
Ø: 65 mm/2 1/2"



21205-4
Vinglas 15 cl 2/kart.
Wine 5 3/10 oz 2/box
H: 170 mm/6 5/8"
Ø: 80 mm/3 1/8"



21206-4
Vinglas 20 cl 2/kart.
Wine 7 oz 2/box
H: 190 mm/7 1/2"
Ø: 85 mm/3 3/8"



21207-4
Vinglas 25 cl 2/kart.
Wine 9 oz 2/box
H: 200 mm/7 7/8"
Ø: 90 mm/3 1/2"



21208-4
Vinglas 30 cl 2/kart.
Wine 11 oz 2/box
H: 210 mm/8 1/4"
Ø: 95 mm/3 3/4"













21221-4
Champ. hög 2/kart.
Champ. flute 2/box
H: 225 mm/8 7/8"
Ø: 60 mm/2 3/8"

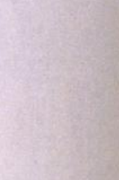
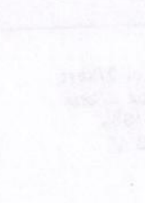
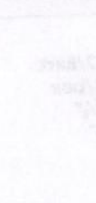
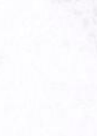

Boda Château

Design:
Bertil Vallien

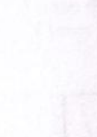
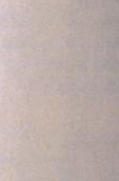
<p>21222-4 Champ. skål 2/kart. Champ. bowl 2/box H: 145 mm/5³/₄" Ø: 95 mm/3³/₄"</p> 	<p>21225-4 Snaps 5 cl 2/kart. Snaps glass 1¹/₆ oz 2/box H: 145 mm/5³/₄" Ø: 50 mm/2"</p> 	<p>21231-4 Cognac 15 cl 2/kart. Cognac 5³/₁₀ oz 2/box H: 115 mm/4¹/₂" Ø: 50 mm/2"</p> 	<p>21232-4 Cognac 30 cl 2/kart. Cognac 10³/₆ oz 2/box H: 135 mm/5³/₈" Ø: 55 mm/2¹/₈"</p> 
			
			
			

Design:
Signe Persson-Melin

Boda Flagg

28490-2
Brännvin 6 cl 4/kart.
Snaps 2¹/₁₀ oz 4/box
H: 95 mm/3³/₄"
Ø: 35 mm/1³/₈"



28483-2
Cocktail 10 cl 4/kart.
Cocktail 3¹/₂ oz 4/box
H: 69 mm/2³/₄"
Ø: 67 mm/2³/₈"



28481-2
O F 22 cl 4/kart.
O F 7⁷/₁₀ oz 4/box
28449-2 lös, loose
H: 80 mm/3¹/₈"
Ø: 79 mm/3¹/₈"



28482-2
Tumbler 40 cl 4/kart.
Tumbler 14¹/₁₀ oz 4/box
28444-2 lös, loose
H: 135 mm/5³/₈"
Ø: 80 mm/3¹/₈"



94192-2
Tumbler 20 cl 4/kart.
Tumbler 7 oz 4/box
H: 136 mm/5³/₈"
Ø: 57 mm/2¹/₈"



28432-2
Grogg 35 cl
Highball 12³/₁₀ oz
H: 170 mm/6⁵/₈"
Ø: 64 mm/2¹/₂"



94140-2
Dessertskål 4/kart.
Dessertbowl 4/box
H: 65 mm/2¹/₂"
Ø: 105 mm/4¹/₈"

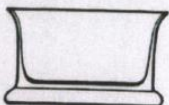

28479-2
Ishink 1/kart.
Icebucket 1/box
H: 120 mm/4³/₄"
Ø: 120 mm/4³/₄"

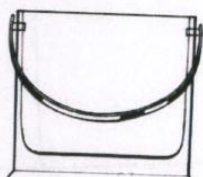

28429-2
Sejdel 50 cl 1/kart.
Beer mug 17³/₅ oz 1/box
H: 155 mm/6¹/₈"
Ø: 100 mm/4"

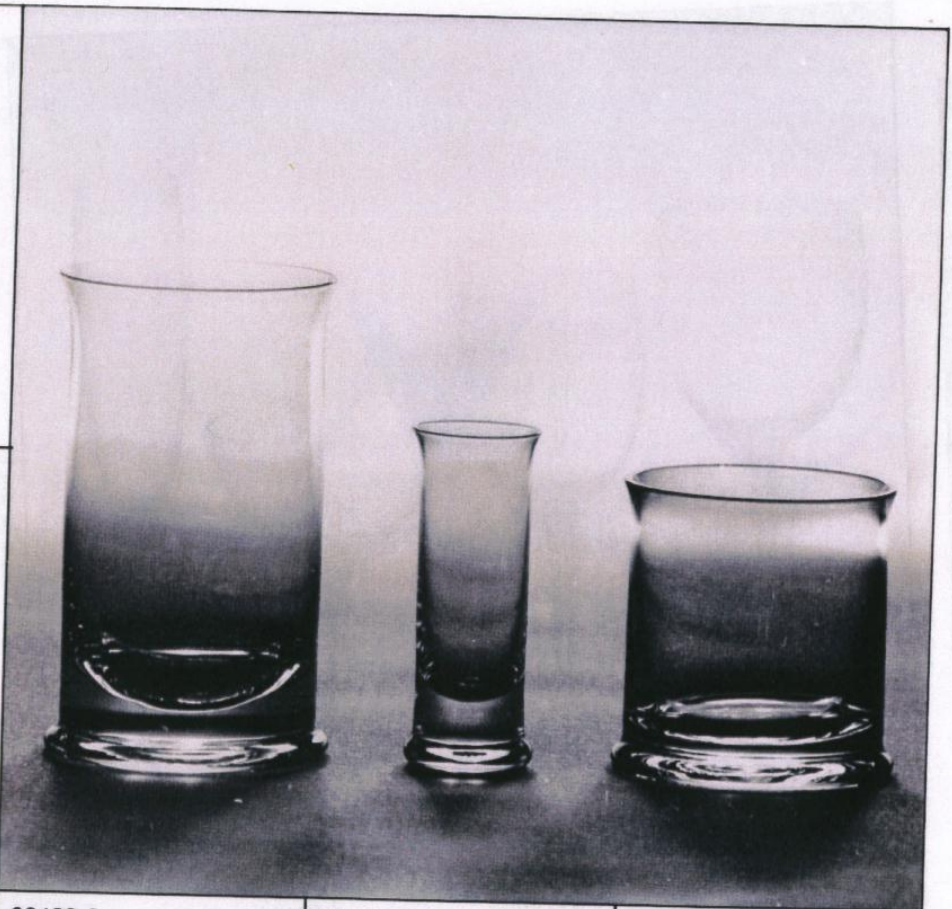

Boda Louise

Design:
Arne Branzell

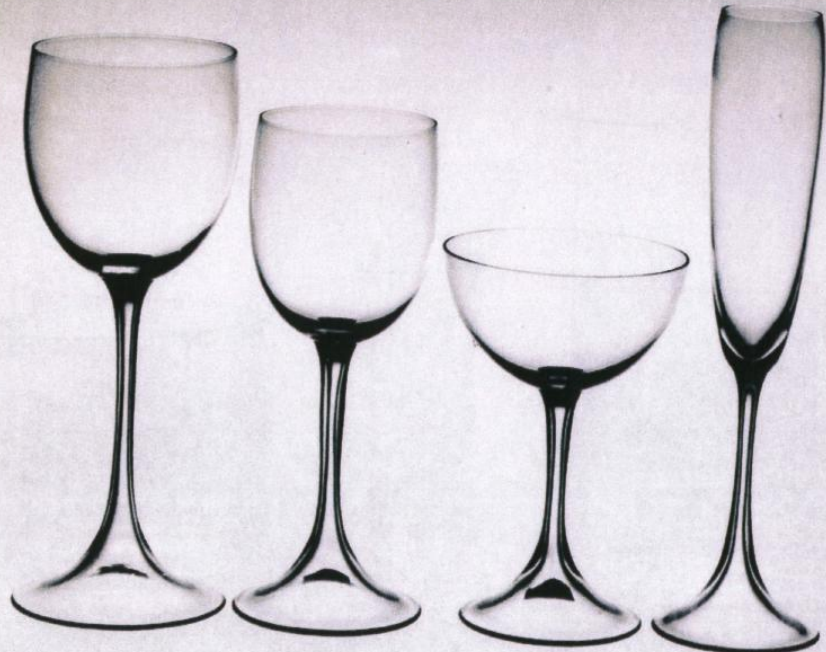

23903-4
Vinglas 7 1/2 cl
Wine glass 2 3/5 oz
H: 165 mm/6 1/2"
Ø: 56 mm/2 1/8"



23904-4
Vinglas 12 cl
Wine glass 4 1/5 oz
H: 190 mm/7 1/2"
Ø: 66 mm/2 1/2"



23906-4
Vinglas 22 cl
Wine glass 7 7/10 oz
H: 220 mm/8 5/8"
Ø: 73 mm/3"



23908-4
Vinglas 30 cl
Wine glass 10 3/5 oz
H: 230 mm/9"
Ø: 81 mm/3 1/8"



23921-4
Champagne högt
Champagne tall
H: 245 mm/9 5/8"
Ø: 46 mm/1 3/4"



23922-4
Champagneskål
Champagnebowl
H: 150 mm/5 7/8"
Ø: 98 mm/4"



23925-4
Brännvinsglas
Snaps
H: 165 mm/6 1/2"
Ø: 55 mm/2 1/8"



Design:
Arne Branzell

Boda Marie

20703-4
Vin 7 1/2 cl
Wine 2 1/2 oz
H: 140 mm/5 1/2"
Ø: 60 mm/2 3/8"



20704-4
Vin 12 cl
Wine 4 oz
H: 170 mm/6 5/8"
Ø: 65 mm/2 1/2"

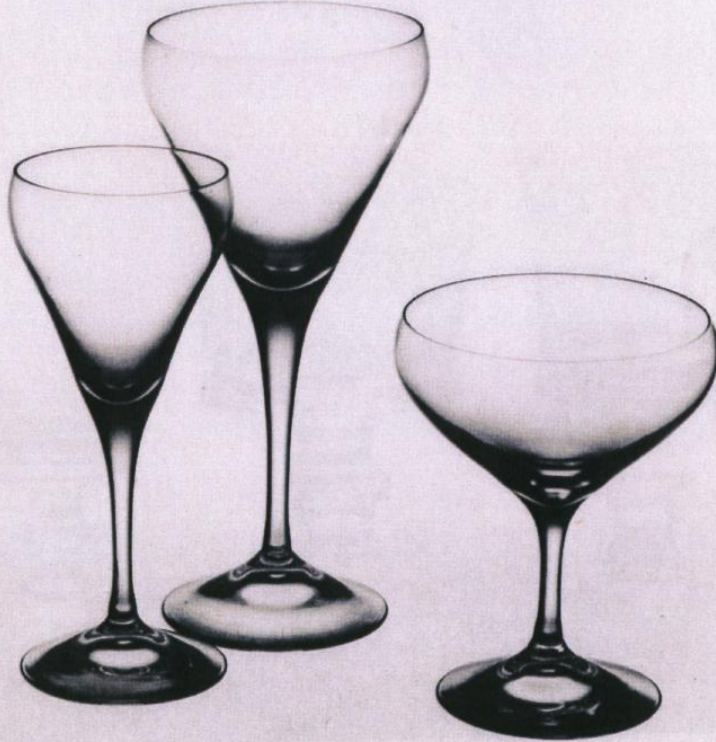

20706-4
Vin 22 cl
Wine 7 1/2 oz
H: 185 mm/7 1/4"
Ø: 85 mm/3 3/8"



20708-4
Vin 30 cl
Wine 10 oz
H: 205 mm/8"
Ø: 90 mm/3 1/2"



20709-4
Vin 35 cl
Wine 12 oz
H: 220 mm/8 5/8"
Ø: 100 mm/4"



20722-4
Champ.skål 22 cl
Champ.bowl 7 1/2 oz
H: 130 mm/5 1/8"
Ø: 90 mm/3 1/2"



20721-4
Champ. högt 20 cl
Champ. tall 7 oz
H: 195 mm/7 5/8"
Ø: 55 mm/2 1/8"



20725-4
Snaps 6 cl
Snaps 2 1/10 oz
H: 145 mm/5 3/4"
Ø: 50 mm/2"



Boda Merlin

Design:
Signe Persson-Melin



28694-2
Brännvin 5 cl 4/kart.
Snaps 1⁴/₅ oz 4/box
H: 93 mm/3³/₄"
Ø: 43 mm/1³/₄"



28688-2
Vin 7¹/₂ cl 4/kart.
Wine 2³/₅ oz 4/box
H: 98 mm/4"
Ø: 52 mm/2"



28690-2
Vin 15 cl 4/kart.
Wine 5³/₁₀ oz 4/box
H: 135 mm/5³/₈"
Ø: 73 mm/3"



28691-2
Vin 25 cl 4/kart.
Wine 8⁴/₅ oz 4/box
H: 147 mm/5³/₄"
Ø: 82 mm/3¹/₈"



28642-2
Tumbler 15 cl
Tumbler 5³/₁₀ oz
H: 68 mm/2⁵/₈"
Ø: 70 mm/2³/₄"

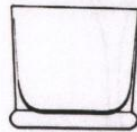

Design:
Signe Persson-Melin

Boda Porter

94122-2
Brännvin 5 cl 2/kart.
Snaps 1⁴/₅ oz 2/box
29239-2 lös, loose
H: 81 mm/3¹/₈"
Ø: 42 mm/1¹/₂"



94116-2
Tumbler 7¹/₂ cl 2/kart.
Tumbler 2³/₅ oz 2/box
29241-2 lös, loose
H: 74 mm/3"
Ø: 56 mm/2¹/₈"

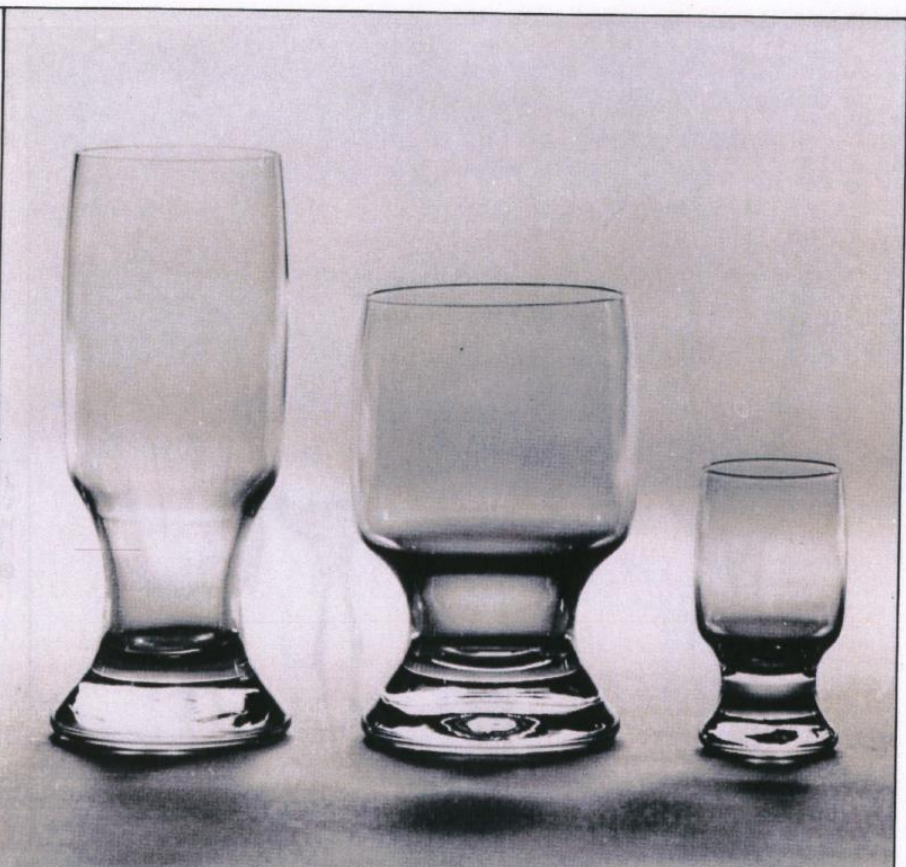

94120-2
Tumbler 22 cl 2/kart.
Tumbler 7⁷/₁₀ oz 2/box
H: 77 mm/3¹/₈"
Ø: 75 mm/3"



29250-2
Tumbler 28 cl
Tumbler 9⁹/₁₀ oz
H: 95 mm/3³/₄"
Ø: 85 mm/3³/₈"



94118-2
Tumbler 20 cl 2/kart.
Tumbler 7 oz 2/box
29242-2 lös, loose
H: 102 mm/4"
Ø: 70 mm/2³/₄"



94124-2
Tumbler 25 cl 2/kart.
Tumbler 8⁴/₅ oz 2/box
29244-2 lös, loose
H: 110 mm/4³/₈"
Ø: 78 mm/3¹/₈"



94047-2
Tumbler 35 cl 2/kart.
Tumbler 12³/₁₀ oz 2/box
29246-2 lös, loose
H: 127 mm/5"
Ø: 80 mm/3¹/₈"



94046-2
Tumbler 40 cl 2/kart.
Tumbler 14¹/₁₀ oz 2/box
H: 170 mm/6⁵/₈"
Ø: 61 mm/2³/₈"

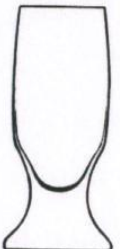

94093-2
Dessertskål 30 cl 2/kart.
Dessertbowl 10³/₅ oz 2/box
29235-2 lös, loose
H: 87 mm/3³/₈"
Ø: 91 mm/3¹/₂"



99250-2
Sejdel 50 cl
Beer mug 17³/₅ oz
H: 130 mm/5¹/₈"
Ø: 90 mm/3¹/₂"



Boda Romans

Boda Romance

Design:
Anna Ehrner



20603-2
Sherry 7¹/₂ cl
Sherry 2³/₅ oz
H: 145 mm/5³/₄"
Ø: 65 mm/2¹/₂"



20604-2
Vin 10 cl
Wine 3¹/₂ oz
H: 170 mm/6⁵/₈"
Ø: 80 mm/3¹/₈"



20605-2
Vin 15 cl
Wine 5³/₁₀ oz
H: 190 mm/7¹/₂"
Ø: 90 mm/3¹/₂"



20621-2
Champ. högt 15 cl
Champ. tall 5³/₁₀ oz
H: 215 mm/8¹/₂"
Ø: 70 mm/2³/₄"





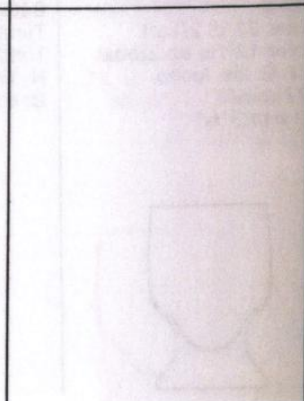
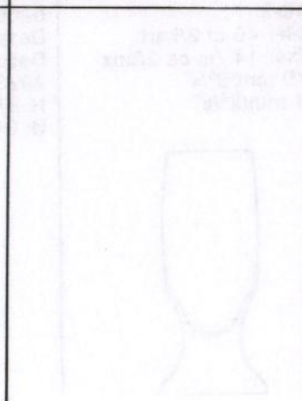
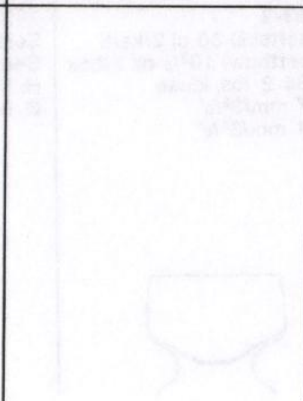





20607-2
Öl 25 cl
Beer 8⁴/₅ oz
H: 205 mm/8"
Ø: 95 mm/3³/₄"



Design:
Bertil Vallien













Boda Ulrica



<p>21101-4 Vinglas 3 cl 2/pack Wine 1 oz 2/box H: 125 mm/4⁷/₈" Ø: 50 mm/2"</p> 	<p>21103-4 Vinglas 7¹/₂ cl 2/kart. Wine 3 oz 2/box H: 145 mm/5³/₄" Ø: 60 mm/2³/₈"</p> 	<p>21104-4 Vinglas 10 cl 2/kart. Wine 4 oz 2/box H: 155 mm/6¹/₈" Ø: 65 mm/2¹/₂"</p> 	<p>21105-4 Vinglas 15 cl 2/kart. Wine 5³/₁₀ oz 2/box H: 175 mm/6⁷/₈" Ø: 70 mm/2³/₄"</p> 
<p>21106-4 Vinglas 20 cl 2/kart. Wine 7 oz 2/box H: 190 mm/7¹/₂" Ø: 80 mm/3¹/₈"</p> 	<p>21107-4 Vinglas 25 cl 2/kart. Wine 9 oz 2/box H: 205 mm/8" Ø: 85 mm/3³/₈"</p> 	<p>21108-4 Vinglas 30 cl 2/kart. Wine 11 oz 2/box H: 210 mm/8¹/₄" Ø: 90 mm/3¹/₂"</p> 	<p>21121-4 Champ. hög 2/kart. Champ. flute 2/box H: 240 mm/9¹/₂" Ø: 45 mm/1³/₄"</p> 

Boda Ulrica

Design:
Bertil Vallien

<p>21122-4 Champ. skål 2/kart. Champ. bowl 2/box H: 145 mm/5³/₄" Ø: 95 mm/3³/₄"</p>	<p>21125-4 Snaps 5 cl 2/kart. Snaps glass 1¹/₅ oz 2/box H: 150 mm/5⁷/₈" Ø: 50 mm/2"</p>	<p>21131-4 Cognac 15 cl 2/kart. Cognac 5³/₁₀ oz 2/box H: 115 mm/4¹/₂" Ø: 50 mm/2"</p>	<p>21132-4 Cognac 30 cl 2/kart. Cognac 10³/₅ oz 2/box H: 135 mm/5³/₈" Ø: 55 mm/2¹/₈"</p>
			
			
			

**Serier
Other Glass Ranges**



Crystal

Design:
Anna Ehrner

Kosta April/September



58041-1
Skål September blå
Bowl September blue
Ø: 130 mm/5 1/8"



58042-1
Skål September blå
Bowl September blue
Ø: 180 mm/7 1/8"



78041-1
Fat September blå
Dish September blue
Ø: 330 mm/14 1/4"



58043-1
Skål April rosa
Bowl April pink
Ø: 160 mm/6 1/4"



58044-1
Skål April rosa
Bowl April pink
Ø: 230 mm/9"



78043-1
Fat April rosa
Dish April pink
Ø: 320 mm/12 1/2"



Kosta Atlantic

Crystal

Design:
Göran Wärff

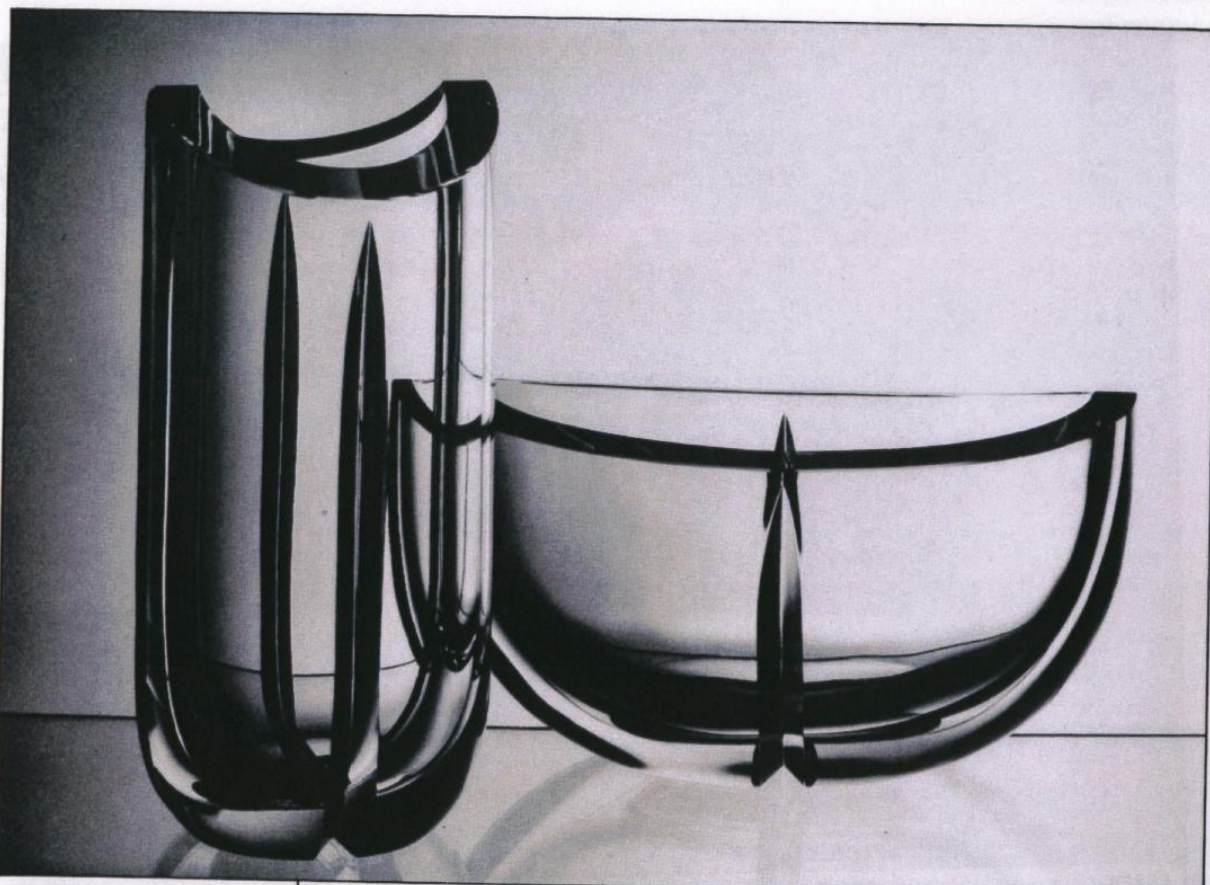

48005-1
Vas rund
Vase round
H: 190 mm/7 1/2"
Ø: 140 mm/5 1/2"

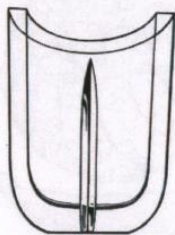

48006-1
Vas rund
Vase round
H: 240 mm/9 1/2"
Ø: 110 mm/4 3/8"

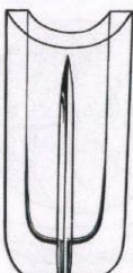

48007-1
Vas oval
Vase oval
H: 190 mm/7 1/2"
Ø: 180 x 130 mm/7 1/8 x 5 1/8"

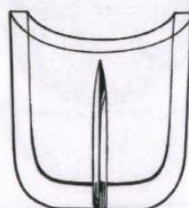

58005-1
Skål rund
Bowl round
H: 105 mm/4 1/8"
Ø: 170 mm/6 5/8"

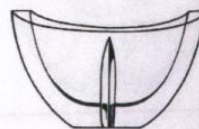

58006-1
Skål rund
Bowl round
H: 120 mm/4 3/4"
Ø: 215 mm/8 1/2"

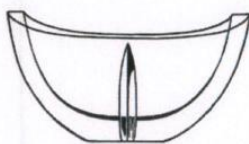

58007-1
Skål oval
Bowl oval
H: 105 mm/4 1/8"
Ø: 190 x 130 mm/7 1/2 x 5 1/8"



58008-1
Skål oval
Bowl oval
H: 120 mm/4 3/4"
Ø: 240 x 160 mm/9 1/2 x 6 1/4"



58009-1
Skål oval
Bowl oval
H: 165 mm/6 1/2"
Ø: 225 x 150 mm/8 7/8 x 5 7/8"

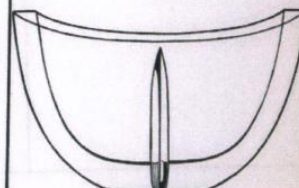

Crystal

Design:
Mats Jonasson

Kosta Blad
Kosta Leaf



55138-1
Konfektskål
Candy bowl
Ø: 120 mm/4 3/4"



55139-1
Fruktskål
Fruit bowl
H: 75 mm/3"
Ø: 200 mm/7 7/8"



77140-1
Fat
Dish
Ø: 220 mm/8 5/8"

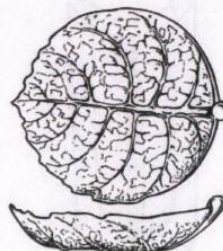

77141-1
Fat
Dish
Ø: 280 mm/11"

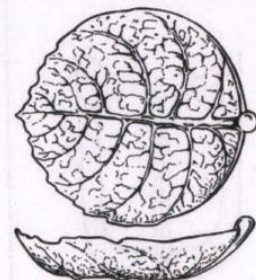

Kosta Blåklocka Kosta Bluebell

Crystal

Design:
Mats Jonasson



48030-1
Vas 1/kart.
Vase 1/box
H: 105 mm/4 $\frac{1}{8}$ "
Ø: 125 mm/4 $\frac{7}{8}$ "

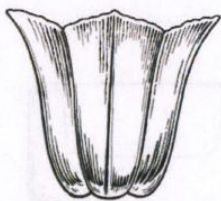

48031-1
Vas
Vase
H: 145 mm/5 $\frac{3}{4}$ "
Ø: 150 mm/5 $\frac{7}{8}$ "

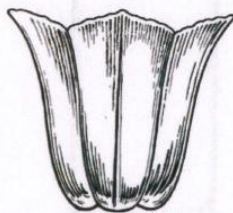

58029-1
Skål 1/kart.
Bowl 1/box
H: 60 mm/2 $\frac{3}{8}$ "
Ø: 140 mm/5 $\frac{1}{2}$ "



58030-1
Skål 1/kart.
Bowl 1/box
Ø: 170 mm/6 $\frac{5}{8}$ "



58031-1
Skål 1/kart.
Bowl 1/box
Ø: 245 mm/9 $\frac{5}{8}$ "



58032-1
Skål 1/kart.
Bowl 1/box
Ø: 325 mm/13 $\frac{1}{2}$ "



Crystal

**Design:
Göran Wärrf**

Kosta Crystal Cube

67980-1
Ljusstake 1/kart.
Candlestick 1/box
H: 75 mm/3"



67981-1
Ljuslykta 1/kart.
Hurricane lamp 1/box
H: 85 mm/3³/₈"



67982-1
Ljuslykta 1/kart.
Hurricane lamp 1/box
H: 105 mm/4¹/₈"



67983-1
Ljuslykta
Hurricane lamp
H: 170 mm/6⁵/₈"



67984-1
Ljusstake
Candlestick
H: 170 mm/6⁵/₈"



77980-1
Askfat
Ashtray
Ø: 130 x 130 mm/5¹/₈ x 5¹/₈"

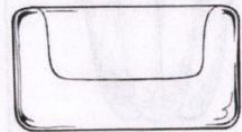

77981-1
Askfat
Ashtray
Ø: 150 x 150 mm/5⁷/₈ x 5⁷/₈"

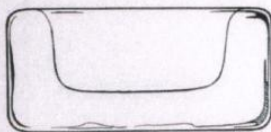

97981-1
Tändare 1/kart.
Lighter 1/box
H: 75 mm/3"

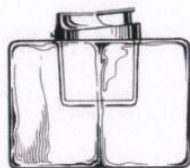

98104-1
Mini Cube
Brevpress
Paperweight
71 x 71 mm/2¹/₂ x 2¹/₂"



Kosta Space Cube

Crystal

Design:
Göran Wärff



48104-1
Vas
Vase
H: 200 mm/7⁷/₈"



48105-1
Vas
Vase
H: 210 mm/8¹/₄"



48106-1
Vas
Vase
H: 280 mm/11"



58104-1
Skål
Bowl
Ø: 160 mm/6¹/₄"

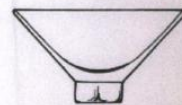

58105-1
Skål
Bowl
Ø: 250 mm/9⁷/₈"

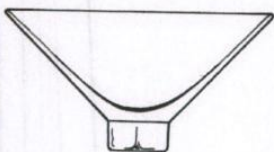

Crystal

Design:
Klas-Göran Tinbäck

Kosta Eight

48107-1
Vas
Vase
H: 185 mm/7 1/4"



48108-1
Vas
Vase
H: 220 mm/8 5/8"

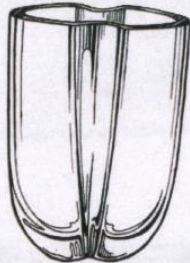

58107-1
Skål
Bowl
H: 85 mm/3 3/8"
Ø: 150 mm/5 7/8"





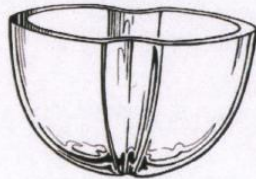

58108-1
Skål
Bowl
H: 120 mm/4 3/4"
Ø: 200 mm/7 7/8"

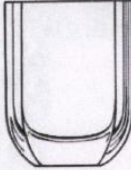
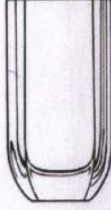

Kosta Four

Crystal

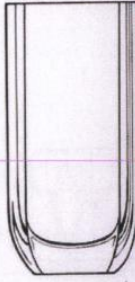
Design:
Klas-Göran Tinbäck

	<p>48113-1 Vas Vase H: 115 mm/4 1/2"</p> 	<p>48114-1 Vas Vase H: 185 mm/7 1/4"</p> 	
	<p>48115-1 Vas Vase H: 230 mm/9"</p> 	<p>48116-1 Vas Vase H: 250 mm/9 7/8"</p> 	
<p>58113-1 Skål Bowl H: 80 mm/3 1/8" Ø: 115 mm/4 1/2"</p> 	<p>58114-1 Skål Bowl H: 105 mm/4 1/8" Ø: 155 mm/6 1/8"</p> 		

Crystal

Design:
Ann Wärff

Kosta Harlekin Kosta Harlequin

47366-1
Vas
Vase
H: 200 mm/7⁷/₈"



57366-1
Skál
Bowl
Ø: 170 mm/6⁵/₈"

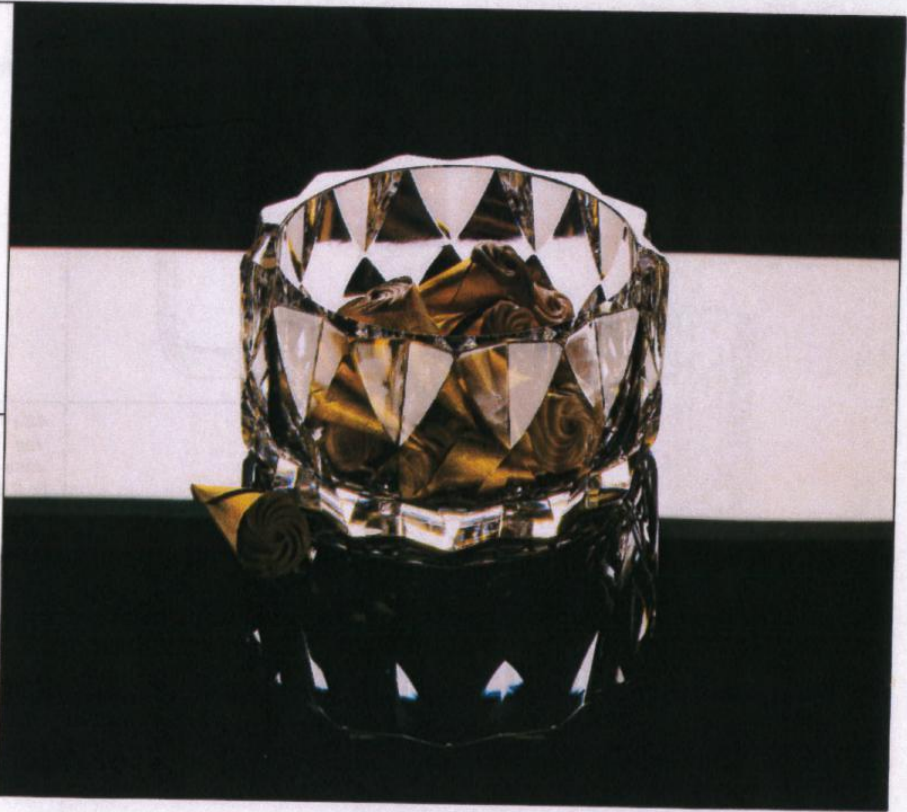

Crystal

Design:
Sigurd Persson

Kosta Noblesse

47872-1
Vas
Vase
H: 180 mm/7¹/₈"
Ø: 120 mm/4³/₄"



57872-1
Skál
Bowl
Ø: 165 mm/6¹/₂"



57873-1
Skál
Bowl
Ø: 200 mm/7⁷/₈"



Kosta Isabella

Crystal

Design:
Anna Ehrner



47644-1
Vas 1/kart.
Vase 1/box
H: 110 mm/4³/₈"



47645-1
Vas 1/kart.
Vase 1/box
H: 140 mm/5¹/₂"

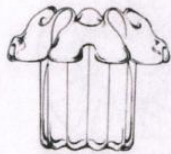

67644-1
Ljuslykta 1/kart.
Hurricane lamp 1/box
H: 75 mm/3"



67648-1
Ljusstake 1/kart.
Candlestick 1/box
H: 110 mm/4³/₈"



67645-1
Ljusstake 1/kart.
Candlestick 1/box
Ø: 100 mm/4"

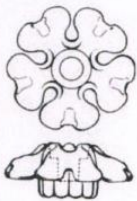

67646-1
Ljusstake-askfat 1/kart.
Candlestick-ashtray 1/box
Ø: 150 mm/5⁷/₈"

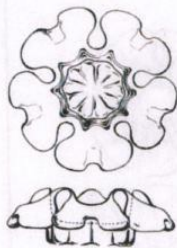

67647-1
Ljusfat-askfat
Candlestick-ashtray
Ø: 200 mm/7⁷/₈"

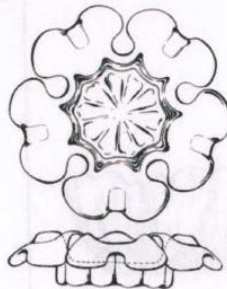

Design:
Mats Jonasson

Kosta Linda

57800-1
Skål 1/kart.
Bowl 1/box
Ø: 120 mm/4³/₄"



57801-1
Skål 1/kart.
Bowl 1/box
Ø: 175 mm/6⁷/₈"

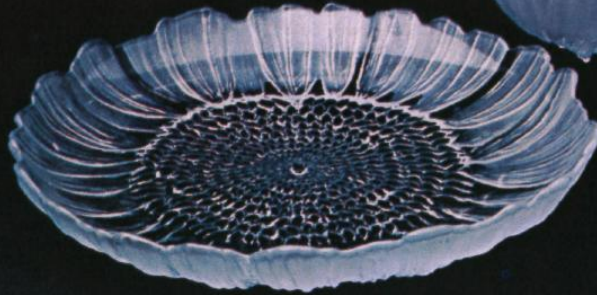

57802-1
Skål 1/kart.
Bowl 1/box
Ø: 210 mm/8¹/₄"



77807-1
Assiett 1/kart.
Plate 1/box
Ø: 170 mm/6⁵/₈"



77802-1
Assiett 1/kart.
Plate 1/box
Ø: 195 mm/7⁵/₈"



77803-1
Tallrik 1/kart.
Plate 1/box
Ø: 270 mm/10⁵/₈"

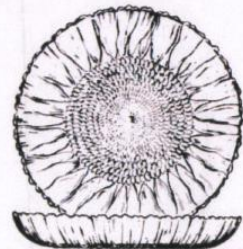

77804-1
Uppläggningsfat 1/kart.
Platter 1/box
Ø: 310 mm/12¹/₄"

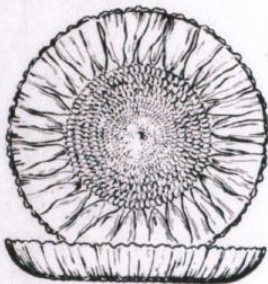

57849-1
Skål 1/kart.
Bowl 1/box
Ø: 240 mm/9¹/₂"



67849-1
Ljusstake 1/kart.
Candlestick 1/box
H: 50 mm/2"
Ø: 110 mm/4³/₈"



Kosta Lotus

Crystal

Design:
Göran Wärff



57390-1

Skål

Bowl

Ø: 145 mm/5³/₄"

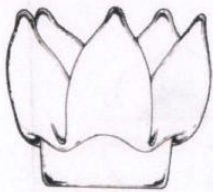

57391-1

Skål

Bowl

Ø: 210 mm/8¹/₄"

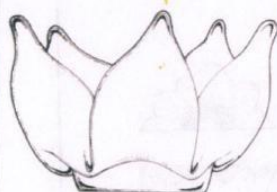

67390-1

Ljusstake

Candlestick

H: 95 mm/3³/₄"



67391-1

Ljusstake 1/kart.

Candlestick 1/box

H: 110 mm/4³/₈"

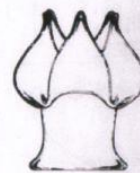

67392-1

Ljusstake

Candlestick

H: 170 mm/6⁵/₈"



Crystal

Design:
Mats Jonasson

Kosta Näckros Kosta Waterlily



57958-1
Skål låg 1/kart.
Bowl low 1/box
H: 70 mm/2³/₄"
Ø: 190 mm/7¹/₂"

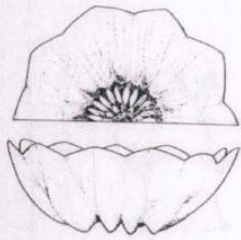

57960-1
Skål hög 1/kart.
Bowl high 1/box
H: 80 mm/3¹/₈"
Ø: 145 mm/5³/₄"

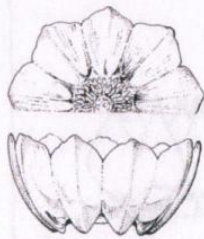

67958-1
Ljusstake 1/kart.
Candlestick 1/box
H: 40 mm/1¹/₂"
Ø: 120 mm/4³/₄"

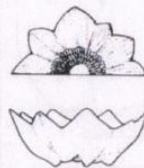

67959-1
Ljuslykta 1/kart.
Hurricane lamp 1/box
H: 65 mm/2¹/₂"
Ø: 125 mm/4⁷/₈"

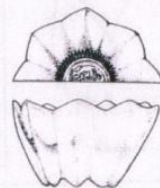

77958-1
Askfat 2/kart.
Ashtray 2/box
H: 35 mm/1³/₈"
Ø: 95 mm/3³/₄"



Kosta Olivia

Crystal

Design:
Anna Ehrner



48027-1
Vas
Vase
H: 200 mm/7⁷/₈"
Ø: 110 mm/4³/₈"



58027-1
Skål 1/kart.
Bowl 1/box
H: 80 mm/3¹/₈"
Ø: 125 mm/4⁷/₈"



58028-1
Skål 1/kart.
Bowl 1/box
H: 110 mm/4³/₈"
Ø: 175 mm/6⁷/₈"



Kosta Optic

Crystal

Design:
Anna Ehrner

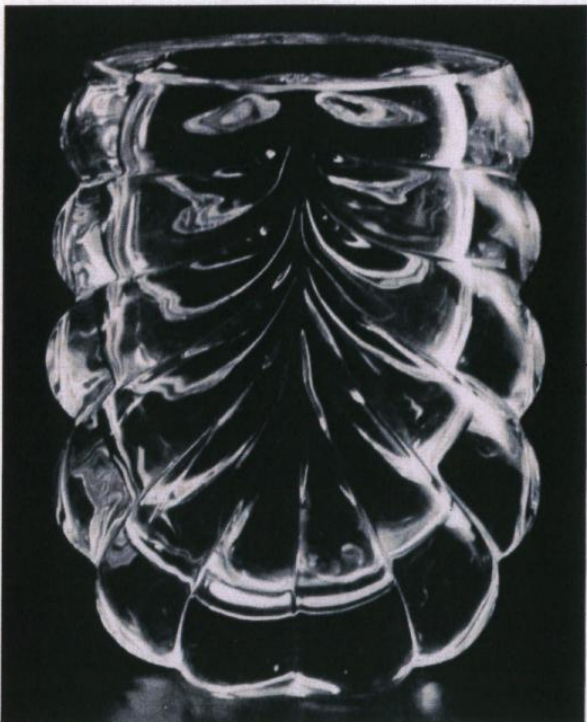

48076-1
Vas Optic
Vase Optic
H: 190 mm/7¹/₂"



88076-1
Karaff
Decanter
H: 230 mm/9"







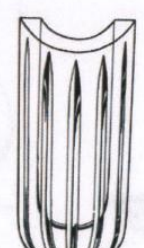
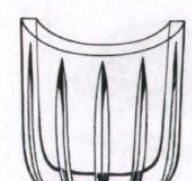

Crystal

Design:
Göran Wärff

Kosta Pacific



<p>48000-1 Vas rund Vase round H: 190 mm/7 1/2" Ø: 140 mm/5 1/2"</p> 	<p>48001-1 Vas rund Vase round H: 240 mm/9 1/2" Ø: 110 mm/4 3/8"</p> 	<p>48002-1 Vas oval Vase oval H: 190 mm/7 1/2" Ø: 180 x 130 mm/7 1/8 x 5 1/8"</p> 	<p>58000-1 Skål rund Bowl round H: 105 mm/4 1/8" Ø: 170 mm/6 5/8"</p> 
<p>58001-1 Skål rund Bowl round H: 120 mm/4 3/4" Ø: 215 mm/8 1/4"</p> 	<p>58002-1 Skål oval Bowl oval H: 190 mm/7 1/2" Ø: 190 x 115 mm/7 1/2 x 4 1/2"</p> 	<p>58003-1 Skål oval Bowl oval H: 145 mm/5 1/2" Ø: 245 x 135 mm/9 5/8 x 5 3/8"</p> 	<p>58004-1 Skål oval Bowl oval H: 140 mm/5 1/2" Ø: 225 x 150 mm/8 7/8 x 5 7/8"</p> 

Kosta Party

Design:
Wärff



57283-1
Skål Avocado 2/kart.
Bowl Avocado 2/box
Ø: 160 mm/6 1/4"



57347-1
Majsskål 2/kart.
Bowl 2/box
Ø: 265 mm/10 3/8"

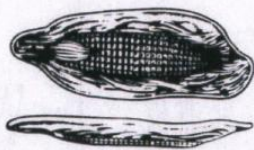

57287-1
Skål Grapefrukt 2/kart.
Bowl Grapefruit 2/box
Ø: 165 mm/6 1/2"



57289-1
Sillfat 1/kart.
Herring-plate 1/box
Ø: 235 mm/9 1/4"

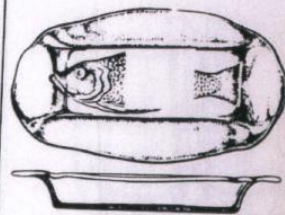

57348-1
Dessertsål 2/kart.
Dessertbowl 2/box
Ø: 115 mm/4 1/2"



57288-1
Skål 1/kart.
Bowl 1/box
Ø: 120 mm/4 3/4"



57285-1
Skål 1/kart.
Bowl 1/box
Ø: 185 mm/7 1/4"















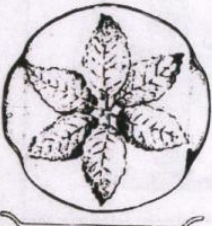

57284-1
Skål 1/kart.
Bowl 1/box
Ø: 230 mm/9"

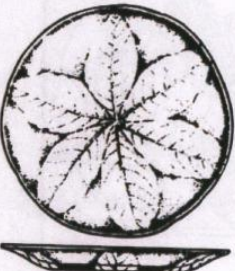

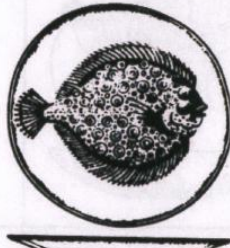









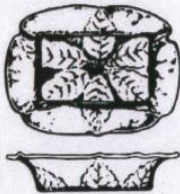

Design:
Wärff

Kosta Party

<p>57345-1 Dessertsål 2/kart. Dessertbowl 2/box Ø: 140 mm/5¹/₂"</p> 	<p>57346-1 Skål 2/kart. Bowl 2/box Ø: 170 mm/6⁵/₈"</p> 	<p>57706-1 Fruktsål 1/kart. Fruit bowl 1/box H: 70 mm/2³/₄" Ø: 185 mm/7¹/₄"</p> 	<p>57707-1 Fruktsål 1/kart. Fruit bowl 1/box H: 80 mm/3¹/₈" Ø: 270 mm/10⁵/₈"</p> 
<p>97505-1 Ostbricka Servingsplate Ø: 270 mm/10⁵/₈"</p> 	<p>97506-1 Ostbricka 1/kart. Servingsplate 1/box Ø: 350 mm/13³/₄"</p> 	<p>77283-1 Asiett 2/kart. Plate 2/box Ø: 180 mm/7¹/₈"</p> 	<p>77285-1 Fat 2/kart. Plate 2/box Ø: 255 mm/10"</p> 
<p>77286-1 Fat 1/kart. Plate 1/box Ø: 330 mm/13"</p> 	<p>77305-1 Fat Krabba 2/kart. Plate Crab 2/box Ø: 260 mm/10¹/₄"</p> 	<p>77153-1 Fat Fisk 2/kart. Plate Fish 2/box Ø: 260 mm/10¹/₄"</p> 	<p>77154-1 Fat Fisk 1/kart. Plate Fish 1/box Ø: 330 mm/13"</p> 
<p>97508-1 Brännvin 2/kart. Snaps 2/box H: 100 mm/4" Ø: 35 mm/1³/₈"</p> 	<p>97349-1 Öl 2/kart. Beer 2/box H: 135 mm/5³/₈"</p> 	<p>97507-1 Öl 40 cl 2/kart. Beer 14 1/10 oz 2/box H: 210 mm/8¹/₄" Ø: 65 mm/2¹/₂"</p> 	<p>87283-1 Kanna 50 cl 1/kart. Jug 17³/₅" oz 1/box</p> 

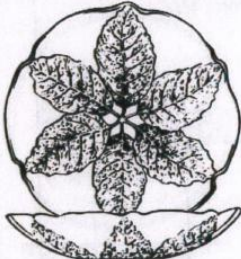
Kosta Party

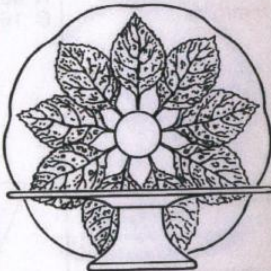
Design:
Wärff

<p>97289-1 Smörbytta 1/kart. Butterdish 1/box Ø: 190x155 mm/7¹/₂"x6¹/₈"</p> 	<p>97283-1 Äggkopp 2/kart. Egg-cups 2/box H: 65 mm/2¹/₂"</p> 	<p>77280-1 Askfat Ashtray Ø: 75 mm/3"</p> 	<p>77281-1 Askfat Ashtray Ø: 110 mm/4³/₈"</p> 
<p>77288-1 Askfat Ashtray Ø: 155 mm/6¹/₈"</p> 	<p>97284-1 Salt/Peppar 2/kart. Salt/Pepper 2/box H: 100 mm/4"</p> 	<p>67283-1 Ljusstake 1/kart. Candlestick 1/box H: 105 mm/4¹/₈"</p> 	<p>57804-1 Skål 1/kart. Bowl 1/box H: 65 mm/2¹/₂" Ø: 210 mm/8¹/₄"</p> 
<p>57805-1 Fruktskål 1/kart. Fruitbowl 1/box H: 65 mm/2¹/₂" Ø: 310 mm/12¹/₄"</p> 	<p>58103-1 Skål på fot 1/kart Bowl ftd 1/box H: 145 mm/5³/₄" Ø: 150 mm/5⁷/₈"</p> 	<p>78101-1 Tårtfat 1/kart. Cakeplate ftd 1/box Ø: 220 mm/8⁵/₈"</p> 	<p>78102-1 Tårtfat 1/kart. Cakeplate ftd 1/box Ø: 320 mm/12¹/₂"</p> 
<p>78103-1 Kakfat 1/kart. Cakeplatter 1/box Ø: 430 x 190 mm/17 x 7¹/₂"</p> 			

Crystal

Design:
Sigurd Persson

Kosta Plaza



57846-1
Skål fyrkantig
Bowl square
H: 70 mm/2³/₄"
Ø: 135 mm/5³/₈"



57847-1
Skål fyrkantig
Bowl square
H: 80 mm/3¹/₈"
Ø: 160 mm/6¹/₄"



57848-1
Skål fyrkantig
Bowl square
H: 100 mm/4"
Ø: 210 mm/8¹/₄"

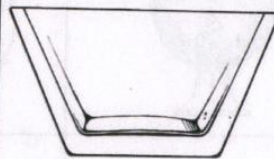

47846-1
Vas
Vase
H: 120 mm/4³/₄"

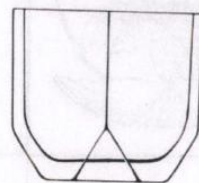

47847-1
Vas
Vase
H: 175 mm/6⁷/₈"

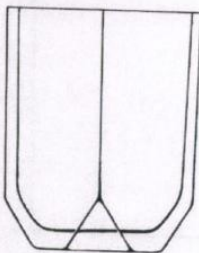

47848-1
Vas
Vase
H: 210 mm/8¹/₄"

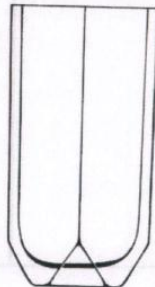

47931-1
Vas
Vase
H: 130 mm/5¹/₈"

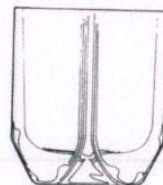

Kosta Prince

Crystal

Design:
Wärff



46194-1
Vas
Vase
H: 180 mm/7¹/₈"

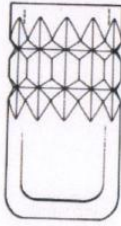

46198-1
Vas fyrkantig 1/kart.
Vase square 1/box
H: 165 mm/6¹/₂"

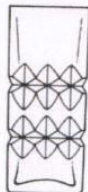

46202-1
Vas rektangulär hög 1/kart.
Vase rectangular high
1/box
H: 210 mm/8¹/₄"

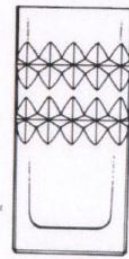

56190-1
Skål
Bowl
Ø: 120 mm/4³/₄"

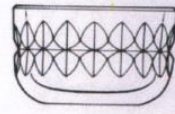

56191-1
Skål
Bowl
Ø: 165 mm/6¹/₂"

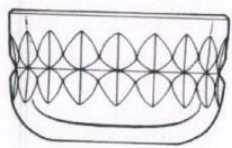

66200-1
Ljusstake
Candlestick
H: 170 mm/6⁵/₈"



66201-1
Ljusstake
Candlestick
H: 220 mm/8⁷/₈"



66202-1
Ljusstake
Candlestick
H: 270 mm/10⁵/₈"



Crystal

Design:
Wärff

Kosta Prince
Kosta Prince

66205-1
Ljusstake 2/kart.
Candlestick 2/box
H: 75 mm/3"

76154-1
Ashfat 1/kart.
Ashtray 1/box
Ø: 130 mm/5 1/8"

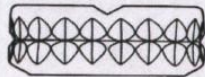
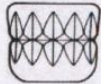

Kosta Royal

Crystal

Design:
Anna Ehrner



47755-1
Vas
Vase
H: 150 mm/5⁷/₈"



47756-1
Vas
Vase
H: 180 mm/7¹/₈"



47833-1
Vas
Vase
H: 210 mm/8¹/₄"



57756-1
Skål
Bowl
Ø: 200 mm/7⁷/₈"



57755-1
Skål
Bowl
Ø: 150 mm/5⁷/₈"



Design:
Anna Ehrner

Boda Anna

78056-2
Tårtfat 1/kart.
Cake platter 1/box
Ø: 310 mm/12 1/4"
H: 90 mm/3 1/2"



88052-2
Karaff 80 cl 1/kart.
Decanter 28 oz 1/box
H: 220 mm/8 5/8"



98052-2
Vin 2/kart.
Wine 2/box
H: 165 mm/6 1/2"
Ø: 75 mm/3"



98053-2
Dricksglas 2/kart.
Tumbler 2/box
H: 130 mm/5 1/8"
Ø: 75 mm/3"



Boda Ann-Marie

Design:
Arne Branzell

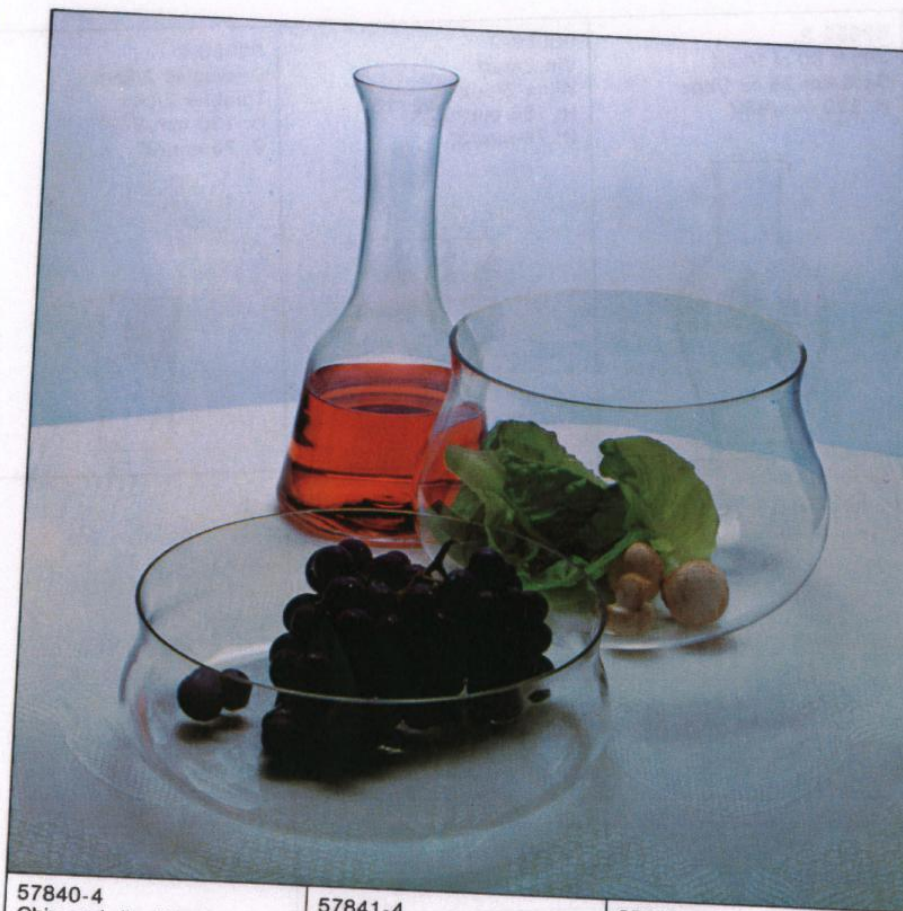

57832-4
Skål 1/kart.
Bowl 1/box
Ø: 200 mm/7⁷/₈"

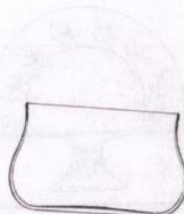

57833-4
Skål 1/kart.
Bowl 1/box
H: 65 mm/2³/₄"
Ø: 230 mm/9"

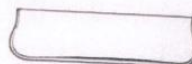

57840-4
Chip and dip 1/kart.
Chip and dip 1/box
Ø: 275 mm/10⁷/₈"



57841-4
Chip and dip 1/kart.
Chip and dip 1/box
Ø: 320 mm/12¹/₂"

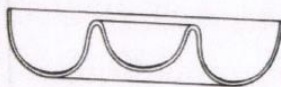

87832-4
Karaff 1/kart.
Decanter 1/box
H: 245 mm/9⁵/₈"

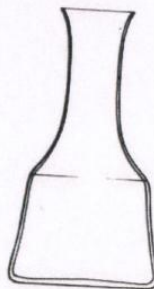

87834-4
Kanna
Jug
H: 190 mm/7¹/₂"
Ø: 100 mm/4"



57860-4
Räskål 1/kart.
Shrimpbowl 1/box
Ø: 170 mm/6⁵/₈"



57861-4
Räskål 1/kart.
Shrimpbowl 1/box
Ø: 210 mm/8¹/₄"

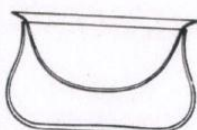







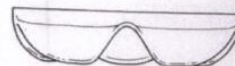



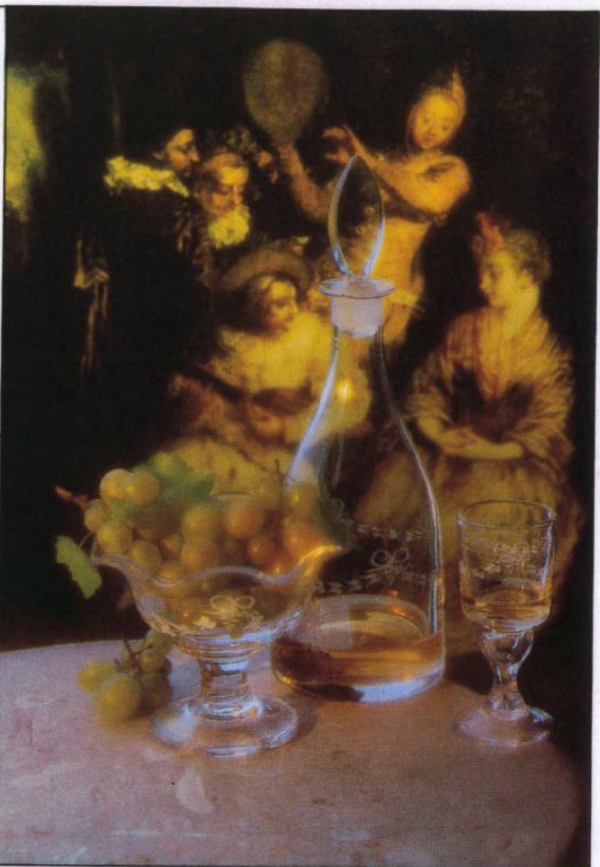

57914-4
Skål 3-delad 1/kart.
Bowl 3-sectioned 1/box
Ø: 210 mm/8¹/₄"

















57915-4
Skål 5-delad 1/kart.
Bowl 5-sectioned 1/box
Ø: 260 mm/10¹/₄"



Boda Reijmyre Antik

<p>24401-2 Likörglas 3 cl Liqueur glass 1 oz H: 113 mm/4 1/2" Ø: 40 mm/1 1/2"</p> 	<p>24402-2 Vinglas 5 cl Wine 2 oz H: 120 mm/4 3/4" Ø: 43 mm/1 3/4"</p> 		
<p>24403-2 Vinglas 8 cl 1/kart. Wine 2 1/2 oz 1/box H: 120 mm/4 3/4" Ø: 54 mm/2 1/4"</p> 	<p>24405-2 Vinglas 15 cl Wine 5 oz H: 150 mm/6" Ø: 63 mm/2 1/2"</p> 		
<p>24406-2 Vinglas 20 cl 1/kart. Wine 6 oz 1/box H: 165 mm/6 1/2" Ø: 65 mm/2 1/2"</p> 	<p>24407-2 Vinglas 25 cl Wine 8 oz H: 180 mm/7" Ø: 70 mm/2 3/4"</p> 	<p>24421-2 Champ. hög Champ. tall H: 195 mm/7 1/2" Ø: 64 mm/2 1/2"</p> 	<p>24425-2 Snaps 4 cl 1/kart. Snaps 1 1/5 oz 1/box H: 150 mm/6" Ø: 55 mm/2 1/4"</p> 
<p>24439-2 Dricksglas 6 cl Tumbler 2 oz H: 57 mm/2 1/4" Ø: 50 mm/2"</p> 	<p>24441-2 Dricksglas 10 cl Tumbler 3 oz H: 67 mm/2 1/2" Ø: 57 mm/2 1/4"</p> 	<p>24442-2 Dricksglas 15 cl Tumbler 5 oz H: 73 mm/2 3/4" Ø: 60 mm/2 1/4"</p> 	<p>24443-2 Dricksglas 20 cl 1/kart. Tumbler 6 oz 1/box H: 83 mm/3 1/4" Ø: 70 mm/2 3/4"</p> 

Boda Reijmyre Antik

<p>24444-2 Dricksglas 23 cl högt Tumbler 7 oz tall H: 133 mm/5 1/4" Ø: 55 mm/2 1/4"</p> 	<p>24447-2 Dricksglas 40 cl Highball 13 oz H: 120 mm/4 3/4" Ø: 70 mm/2 3/4"</p> 	<p>24449-2 Dricksglas OF 25 cl Old fashion 8 oz H: 88 mm/3 1/2" Ø: 78 mm/3"</p> 	<p>24462-2 Karaff 80 cl Decanter 26 oz H: 205 mm/8"</p> 
<p>24463-2 Karaff 80 cl Decanter 26 oz H: 300 mm/12"</p> 	<p>24464-2 Likörkaraff 32 cl Decanter 10 oz H: 210 mm/8 1/2"</p> 	<p>24474-2 Punschglas Punch glass H: 50 mm/2" Ø: 55 mm/2 1/4"</p> 	<p>57890-2 Skål Bowl ftd H: 120 mm/4 3/4" Ø: 140 mm/5 1/2"</p> 
<p>57891-2 Skål Bowl ftd H: 145 mm/5 3/4" Ø: 190 mm/7 1/2"</p> 	<p>57892-2 Skål Bowl H: 110 mm/4 1/4" Ø: 215 mm/8 1/2"</p> 	<p>87890-2 Kanna 75 cl Jug 24 oz H: 195 mm/7 3/4"</p> 	<p>89009-5 Karaff 15 cl Decanter 5 oz H: 115 mm/4 1/2"</p> 
<p>89010-5 Karaff 45 cl Decanter 15 oz H: 145 mm/5 3/4"</p> 	<p>89011-5 Karaff 80 cl Decanter 26 oz H: 180 mm/7 1/4"</p> 	<p>97890-2 Bonbonjär Bonbon H: 200 mm/8"</p> 	

Design:
Bertil Vallien

Boda Arcade

48131-3
Vas 1/kart.
Vase 1/box
H: 125 mm/4 7/8"



48132-3
Vas 1/kart.
Vase 1/box
H: 160 mm/6 1/4"



58131-3
Skål 1/kart.
Bowl 1/box
H: 135 mm/5 3/8"
Ø: 175 mm/6 7/8"

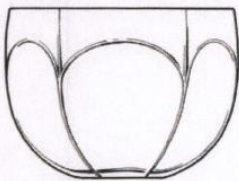

58132-3
Skål 1/kart.
Bowl 1/box
H: 160 mm/6 1/4"
Ø: 210 mm/8 1/4"

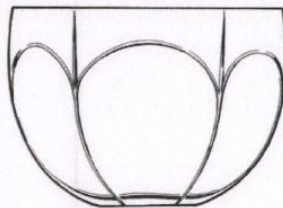

88131-3
Karaff 120 cl 1/kart.
Decanter 42 oz 1/box
H: 210 mm/8 1/4"

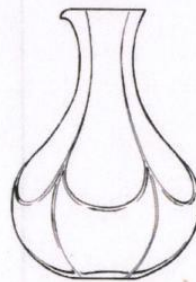





88132-3
Kanna 150 cl 1/kart.
Jug 52 oz 1/box
H: 200 mm/7 7/8"



Boda Cirrus

Design:
Bertil Vallien





	<p>47533-3 Vas Vase H: 190 mm/7 1/2"</p> 	<p>47534-3 Vas 1/kart. Vase 1/box H: 150 mm/5 7/8"</p> 
	<p>57532-3 Skål 1/kart. Bowl 1/box Ø: 190 mm/7 1/2"</p> 	

**Design:
Rolf Sinnemark**

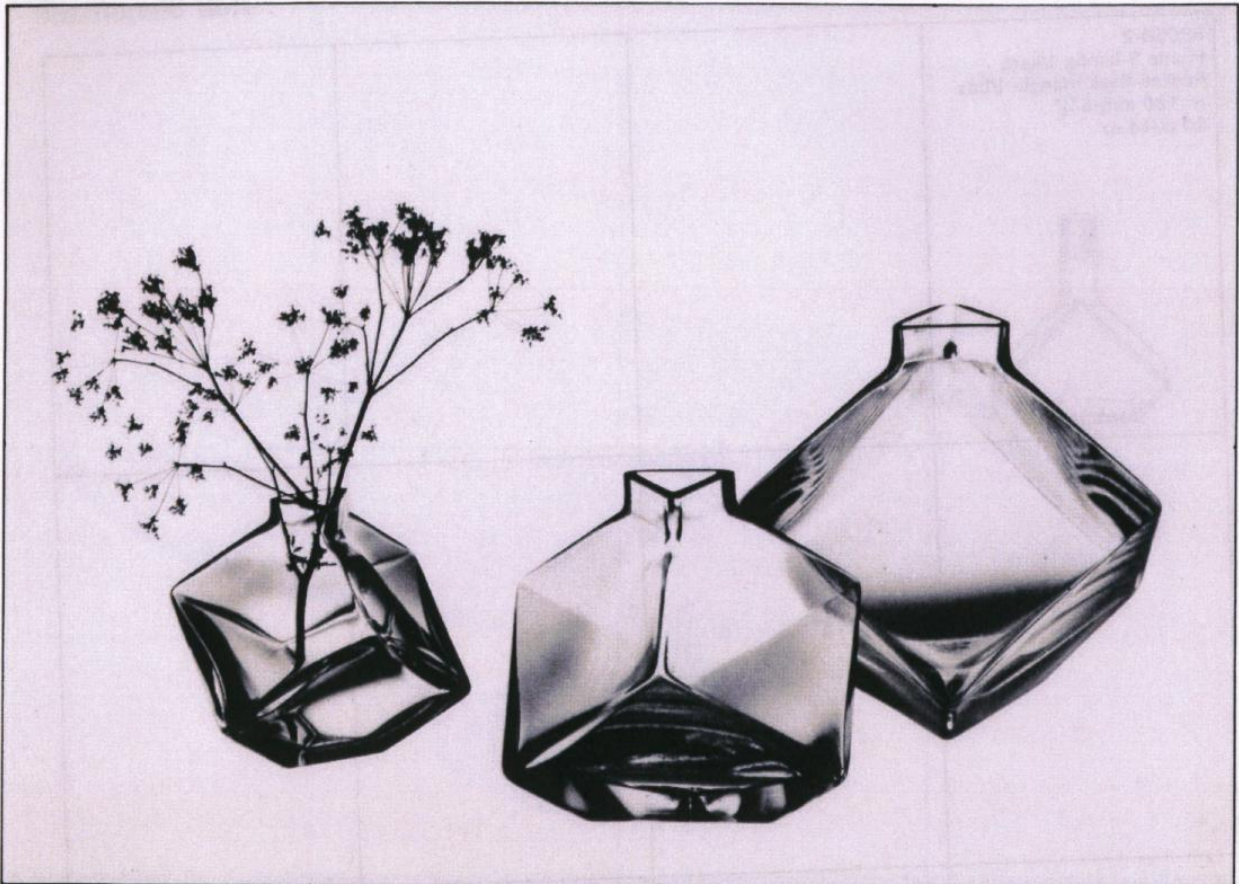
Boda Cubic

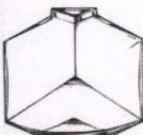
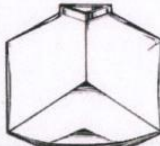
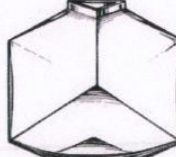
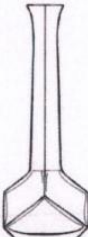

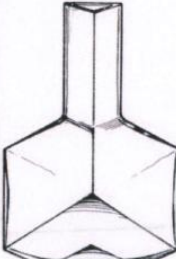
<p>48056-2 Vas 1/kart. Vase 1/box H: 105 mm/4 1/8"</p> 	<p>48057-2 Vas 1/kart. Vase 1/box H: 125 mm/4 7/8"</p> 	<p>48058-2 Vas 1/kart. Vase 1/box H: 155 mm/6 1/8"</p> 	<p>48141-2 Orkidévas 1/kart. Bud vase 1/box H: 220 mm/8 5/8"</p> 
<p>68056-2 Ljusstake 1/kart. Candlestick 1/box H: 70 mm/2 3/4"</p> 	<p>68057-2 Ljuslykta 1/kart. Candleholder 1/box H: 100 mm/4"</p> 	<p>88056-2 Karaff 90 cl 1/kart. Decanter 32 oz 1/box H: 240 mm/9 1/2"</p> 	<p>88057-2 Plunta 4-kant 1/kart. Pocket-flask square 1/box H: 180 mm/7 1/8" 60 cl/21 oz</p> 

Boda Cubic

Design:
Rolf Sinnemark

88058-2
Plunta 3-kantig 1/kart.
Pocket-flask triangle 1/box
H: 150 mm/5 7/8"
40 cl/14 oz

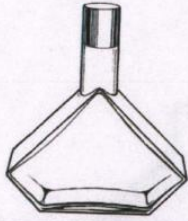

Design:
Paul Hoff

Boda Dessert

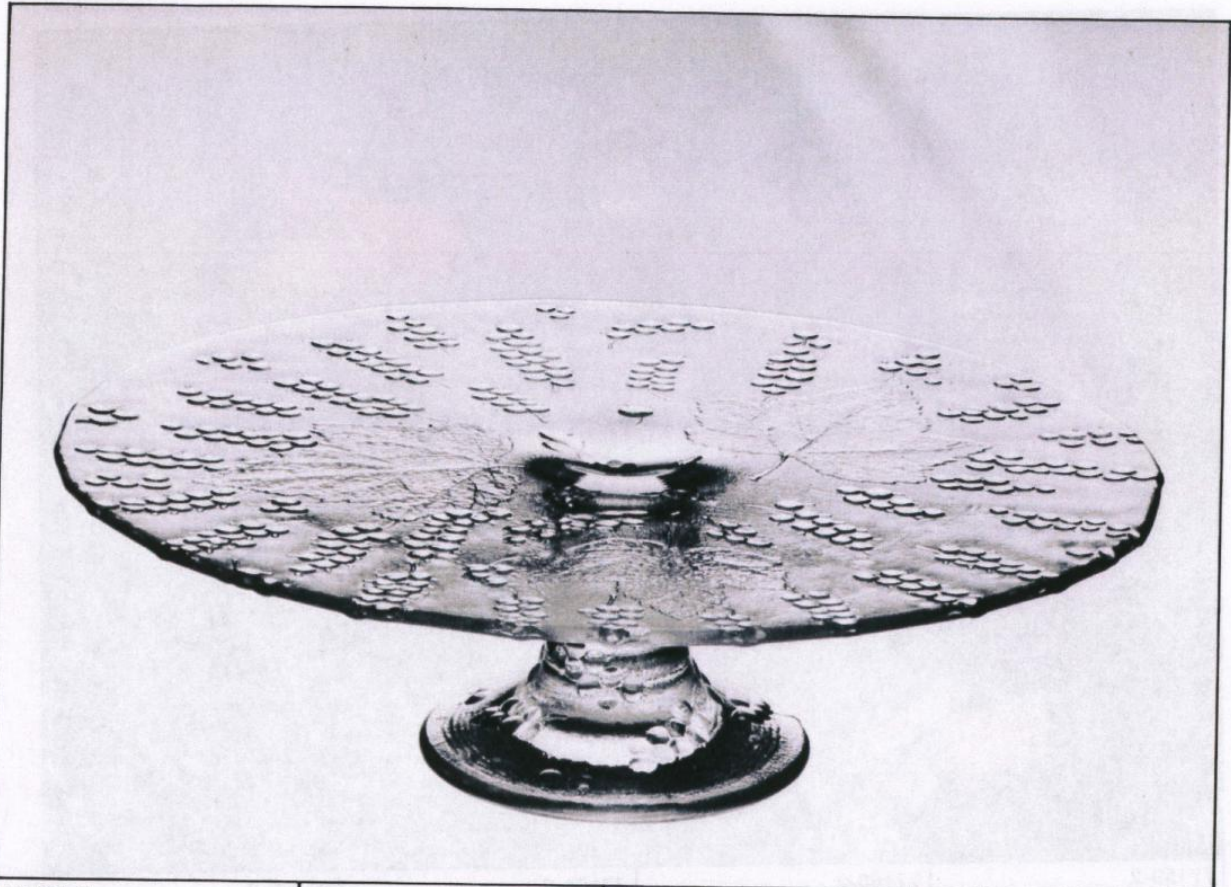

57968-2
Dess.skål på fot 2/kart.
Dess.bowl on foot 2/box
H: 100 mm/4"
Ø: 115 mm/4 1/2"



77968-2
Kakfat på fot 1/kart.
Cake platter on foot 1/box
H: 105 mm/4 1/8"
Ø: 320 mm/12 1/2"



77969-2
Kakfat 1/kart.
Cake platter 1/box
Ø: 340 mm/13 3/8"

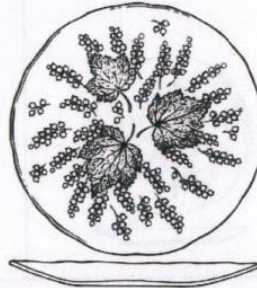

77970-2
Assiett 2/kart.
Plate 2/box
Ø: 170 mm/6 5/8"



Boda Druva Boda Grape

Design:
Ann Wärff

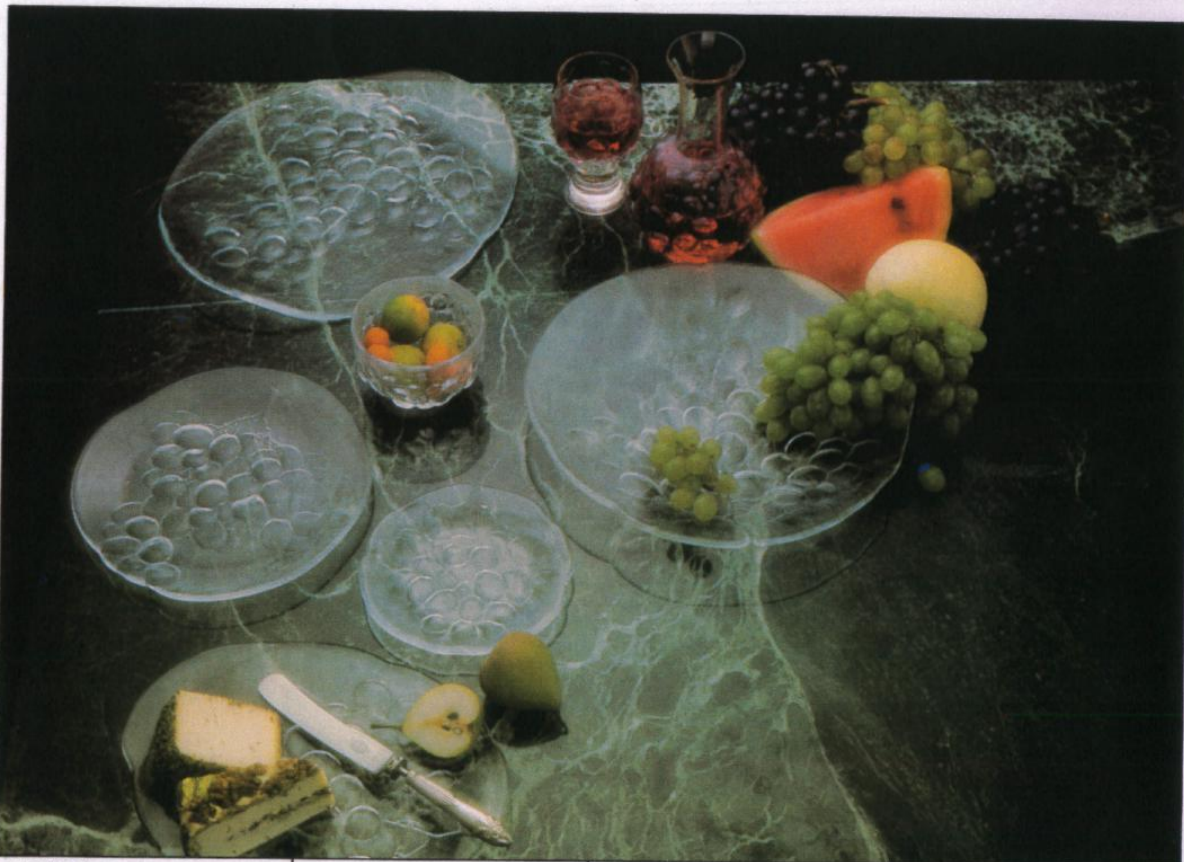

77159-2
Assiett 2/kart.
Plate 2/box
Ø: 180 mm/7¹/₈"



77160-2
Tallrik 2/kart.
Plate 2/box
Ø: 255 mm/10"



77161-2
Fruktfat 1/kart.
Fruitdish 1/box
Ø: 340 mm/13³/₈"

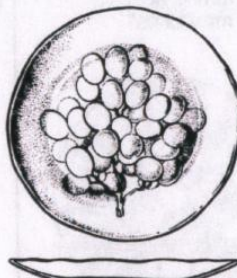

97159-2
Smörgåsbricka 2/kart.
Small platters 2/box
Ø: 220 mm/8⁵/₈"



97160-2
Ostbricka 1/kart.
Small serving plate 1/box
Ø: 320 mm/12¹/₂"

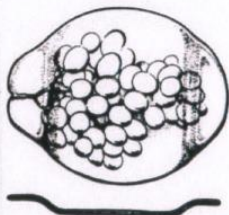

97161-2
Ostbricka 1/kart.
Serving plate 1/box
Ø: 380 mm/15"

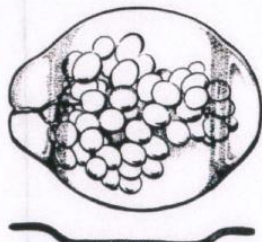

57618-2
Dessertskål 2/kart.
Dessertbowl 2/box
Ø: 135 mm/5³/₁₀"





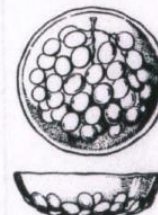





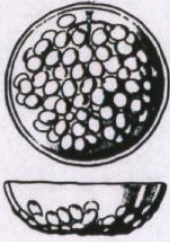

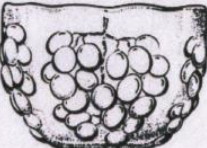
57619-2
Dessertskål 1/kart.
Dessertbowl 1/box
Ø: 170 mm/6⁵/₈"

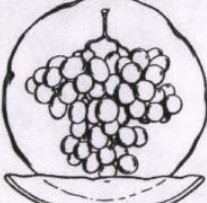

Boda Druva Boda Grape

Design:
Ann Wärff

<p>57620-2 Fruktskål 1/kart. Fruitbowl 1/box Ø: 250 mm/9⁷/₈"</p> 	<p>57554-2 Skål 1/kart. Bowl 1/box Ø: 115 mm/4¹/₂"</p> 	<p>57555-2 Skål 1/kart. Bowl 1/box Ø: 185 mm/7¹/₄"</p> 	<p>57556-2 Skål 1/kart. Bowl 1/box Ø: 225 mm/8⁷/₈"</p> 
<p>97554-2 Öl/vin 30 cl 2/kart Beer/wine 10³/₅ oz 2/box H: 145 mm/5³/₄" Ø: 70 mm/2³/₄"</p> 	<p>87554-2 Karaff 80 cl 1/kart. Decanter 28¹/₅ oz 1/box H: 225 mm/8⁷/₈"</p> 	<p>97742-2 Ishink 1/kart. Ice-bucket 1/box H: 130 mm/5¹/₈"</p> 	<p>77760-2 Frukttfat 1/kart. Fruitdish 1/box Ø: 270 mm/10⁵/₈"</p> 
<p>77805-2 Ostbricka 1/kart. Serving plate 1/box Ø: 320 mm/12¹/₂"</p> 	<p>77806-2 Ostbricka 1/kart. Serving plate 1/box Ø: 260 mm/10¹/₄"</p> 		

Boda Fiesta

Design:
Bertil Vallien



50601-3
Skål 1/kart.
Bowl 1/box
Ø: 210 mm/8¹/₄"

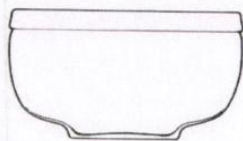

50611-3
Skål
Bowl
Ø: 240 mm/9¹/₂"

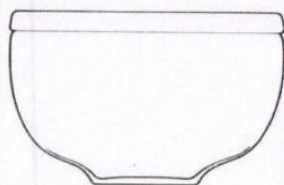

80361-3
Kanna 100 cl
Jug 35¹/₁₀ oz
H: 130 mm/5¹/₈"

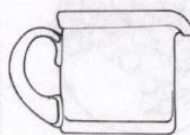

80371-3
Kanna 50 cl 1/kart.
Jug 17³/₅ oz 1/box
H: 195 mm/7⁵/₈"



Boda Fönstersmycken Boda Window ornaments

Design:
Bertil Vallien



97101-3
"Bur" 1/kart.
"Birdcage" 1/box

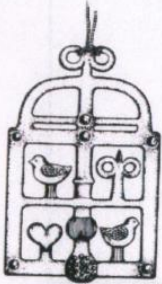

97111-3
"Fågel" 1/kart.
"Bird" 1/box



97121-3
"Hjärta" 1/kart.
"Heart" 1/box



97131-3
"Ljus" 1/kart.
"Candle" 1/box

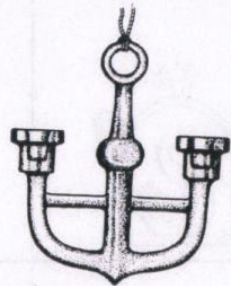

97311-3
"Julstjärna" 1/kart.
"Christmas Star" 1/box



97502-3
"Duva" 1/kart.
"Dove" 1/box



97844-3
"Fågel på gren" 1/kart.
"Bird on branch" 1/box



















97845-3
"Hjärta med blomma" 1/kart.
"Heart with flower" 1/box



Boda Fönstersmycken

Boda Window ornaments

Design:
Bertil Vallien

<p>97846-3 "2 duvor med hjärta" 1/kart. "2 doves with heart" 1/box</p> 	<p>98045-3 "Fågel" 1/kart. "Bird" 1/box Fönstersmycke Window Ornament 125 x 150 mm/4 7/8 x 5 7/8"</p> 	<p>98046-3 "Uggle" 1/kart. "Owl" 1/box Fönstersmycke Window Ornament 210 x 230 mm/8 1/4 x 9"</p> 	<p>98047-3 "Tupp" 1/kart. "Cock" 1/box Fönstersmycke Window Ornament 270 x 240 mm/10 5/8 x 9 1/2"</p> 
<p>98048-3 "Uggle" 1/kart. "Owl" 1/box Fönstersmycke Window Ornament 125 x 150 mm/4 7/8 x 5 7/8"</p> 	<p>98106-3 "Duva" 1/kart. "Dove" 1/box Fönstersmycke Window Ornament H: 150 mm/5 7/8"</p> 	<p>98107-3 "Fågel" 1/kart. "Bird" 1/box Fönstersmycke Window Ornament H: 190 mm/7 1/2"</p> 	<p>98108-3 "Hjärta" 1/kart. "Heart" 1/box Fönstersmycke Window Ornament H: 150 mm/5 7/8"</p> 
<p>98109-3 "Svan" 1/kart. "Swan" 1/box Fönstersmycke Window Ornament 200 x 200 mm/8 x 8"</p> 			
			

**Design:
Bertil Vallien**

Boda H₂O

48033-3
Vas 1/kart.
Vase 1/box
H: 175 mm/6⁷/₈"



48034-3
Vas 1/kart.
Vase 1/box
H: 230 mm/9"



48035-3
Golvas
Floor-vase
H: 350 mm/13³/₄"



58035-3
Skål 1/kart.
Bowl 1/box
H: 90 mm/3¹/₂"
Ø: 140 mm/5¹/₂"



58036-3
Skål 1/kart.
Bowl 1/box
H: 115 mm/4¹/₂"
Ø: 170 mm/6⁵/₈"



58037-3
Skål 1/kart.
Bowl 1/box
H: 135 mm/5¹/₈"
Ø: 200 mm/7⁷/₈"

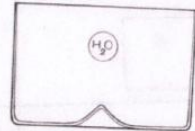

58038-3
Skål 1/kart.
Bowl 1/box
H: 125 mm/4⁷/₈"
Ø: 160 mm/6¹/₄"

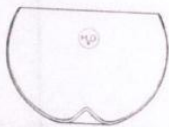

58039-3
Skål 1/kart.
Bowl 1/box
H: 140 mm/5¹/₂"
Ø: 200 mm/7⁷/₈"



88035-3
Karaff smal hals 35 cl
1/kart.
Decanter narrow neck
12³/₁₀ oz 1/box
H: 205 mm/8"











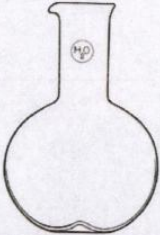

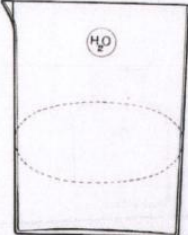
88036-3
Karaff smal hals
75 cl 1/kart.
Decanter narrow neck
26²/₅ oz 1/box
H: 240 mm/9¹/₂"

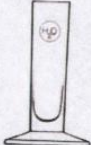

Boda H₂O

Design:
Bertil Vallien

<p>88037-3 Karaff smal hals 100 cl 1/kart. Decanter narrow neck 35 1/10 oz 1/box H: 260 mm/10 1/4"</p> 	<p>88038-3 Karaff bred hals 75 cl 1/kart. Decanter wide neck 26 2/5 oz 1/box H: 210 mm/8 1/4"</p> 	<p>88039-3 Mixer 1/kart. Mixer 1/box H: 230 mm/9"</p> 	<p>88040-3 Kanna 100 cl 1/kart. Jug 35 1/10 oz 1/box H: 180 mm/7 1/8"</p> 
<p>88041-3 Karaff 75 cl 1/kart. Decanter 26 2/5 oz 1/box H: 210 mm/8 1/4"</p> 	<p>98035-3 Brännvin 5 cl 2/kart. Snaps 1 1/5 oz 2/box H: 95 mm/3 3/4" Ø: 35 mm/1 3/8"</p> 	<p>98036-3 Brännvin 3 cl 2/kart. Snaps 1 oz 2/box H: 105 mm/4 1/8" Ø: 30 mm/1 1/4"</p> 	<p>98037-3 Juice 25 cl 2/kart. Juice 8 4/5 oz 2/box H: 120 mm/4 3/4" Ø: 55 mm/2 1/8"</p> 
<p>98038-3 OF 20 cl 2/kart. OF 7 oz 2/box H: 65 mm/2 1/2" Ø: 75 mm/3"</p> 	<p>98039-3 DOF 30 cl 2/kart. DOF 10 3/5 oz 2/box H: 75 mm/3" Ø: 85 mm/3 3/8"</p> 	<p>98040-3 Tumbler 35 cl 2/kart. Highball 12 3/10 oz 2/box H: 175 mm/6 7/8" Ø: 55 mm/2 1/8"</p> 	<p>98041-3 Vas/glas på fot 1/kart. Vase/glass on foot 1/box H: 210 mm/8 1/4" Ø: 45 mm/1 3/8"</p> 
<p>98042-3 Vin 20 cl 2/kart. Wine 7 oz 2/box H: 150 mm/5 7/8" Ø: 75 mm/3"</p> 			

Boda Jennifer

Design:
Ulrica Hydman-Vallien

48050-3
Orkidévas vit/lila 1/kart.
Vase orchide white/lilac
1/box
H: 200 mm/7⁷/₈"



48051-3
Vas vit/lila
Vase white/lilac
H: 225 mm/8⁷/₈"



58050-3
Skål på fot vit/lila
Bowl footed white/lilac
H: 130 mm/5¹/₈"
Ø: 150 mm/5⁷/₈"

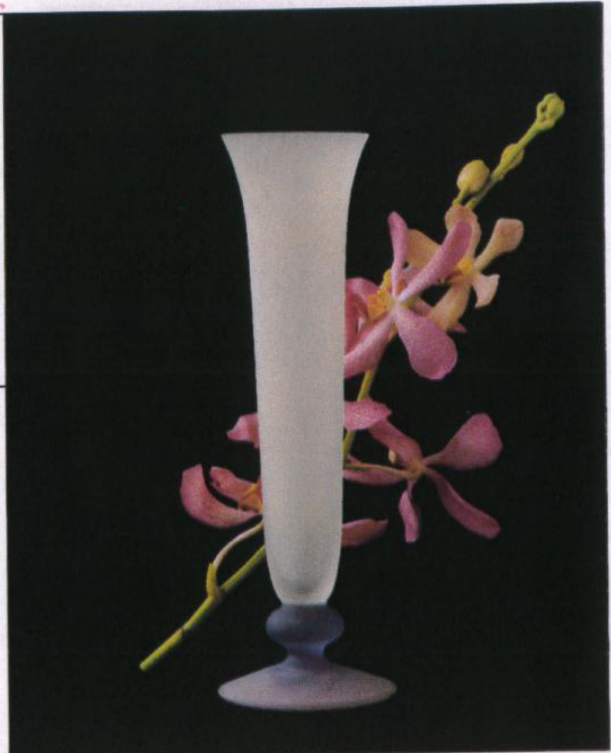

Boda Julprogram Boda Christmas programme

Design:
Bertil Vallien



67640-3
Ljusstake "Gris" 1/kart.
Candlestick "Pig" 1/box
H: 70 mm/2³/₄"



67641-3
Ljusstake "Tomte" m rött ljus
1/kart.
Candlestick "Father Christmas" with red candle 1/box
H: 140 mm/5¹/₂"



67853-3
Ljusstake "Julbock" 1/kart.
Candlestick "Goat" 1/box



67951-3
Ljuslykta "Jul" 1/kart.
Christmas hurricane lamp 1/box
H: 120 mm/4³/₄"



67952-3
Ljuslykta "Tomtar" 1/kart.
Hurricane lamp "Santa Claus" 1/box
H: 120 mm/4³/₄"



68028-3
Ljusstake 1/röd kart.
Candlestick 1/red box

68058-3
Ljusstake
Candlestick
L: 110 mm/4³/₈"



68029-3
Ljusstake 1/röd kart.
Candlestick 1/red box

68059-3
Ljusstake
Candlestick
L: 145 mm/5³/₄"

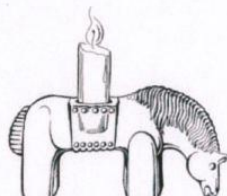

68030-3
Ljusstake 1/röd kart.
Candlestick 1/red box

68060-3
Ljusstake 1/kart.
Candlestick 1/box
L: 265 mm/10³/₈"



68031-3
Adventsljusstake 1/röd kart.
Advent candlestick 1/red box
L: 350 mm/13³/₄"

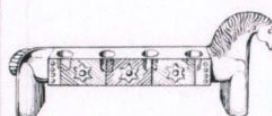



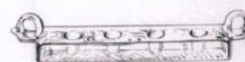







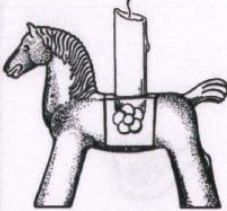



68032-3
Adventsljusstake 1/röd kart.
Advent candlestick 1/red box
L: 320 mm/12¹/₂"



Boda Julprogram Boda Christmas programme













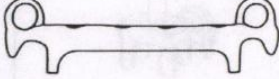
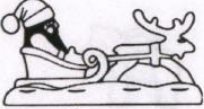

Design:
Bertil Vallien

<p>68033-3 Ljusstake 1/röd kart. Candlestick 1/red box</p> <p>68063-3 Ljusstake Candlestick L: 160 mm/6 1/4"</p> 	<p>68034-3 Ljusstake m grepe 1/röd kart. Candlestick handled 1/red box</p> <p>68064-3 Ljusstake m grepe 1/kart. Candlestick handled 1/box 75 x 75 mm/3 x 3"</p> 	<p>68035-3 Ljusstake 1/röd kart. Candlestick 1/red box</p> <p>68065-3 Ljusstake 1/kart. Candlestick 1/box</p> 	<p>68036-3 Ljusstake 1/röd kart. Candlestick 1/red box</p> <p>68066-3 Ljusstake 1/kart. Candlestick 1/box L: 150 mm/5 7/8"</p> 
<p>78034-3 Askfat m grepe 1/röd kart. Ashtray handled 1/red box</p> <p>78064-3 Askfat m grepe 1/kart. Ashtray handled 1/box 105 x 105 mm/4 1/8 x 4 1/8"</p> 	<p>97482-3 "Häst" 1/kart. "Horse" 1/box H: 50 mm/2"</p> 	<p>97516-3 Ljusstake "Bock" 1/kart. Candlestick "Goat" 1/box H: 95 mm/3 3/4"</p> 	<p>97606-3 "Hornblåsande ängel" 1/kart. "Angel Playing the Horn" 1/box H: 180 mm/7 1/8"</p> 
<p>97690-3 "Tomte" 1/kart. "Father Christmas" 1/box H: 70 mm/2 3/4"</p> 	<p>97691-3 "Klocka" 1/kart. "Bell" 1/box H: 75 mm/2 3/4"</p> 	<p>97692-3 "Ängel" 1/kart. "Angel" 1/box H: 75 mm/2 3/4"</p> 	<p>97693-3 "Stjärna" 1/kart. "Star" 1/box H: 75 mm/2 3/4"</p> 
<p>97694-3 "Julbock" 1/kart. "Christmas goat" 1/box H: 65 mm/2 1/2"</p> 	<p>97695-3 "Julgris" 1/kart. "Christmas pig" 1/box H: 50 mm/2"</p> 	<p>97696-3 "Klocka" stor 1/kart. "Bell" large 1/box H: 230 mm/9"</p> 	<p>97745-3 "Hjärta" 1/kart. "Heart" 1/box H: 50 mm/2"</p> 

Boda Julprogram

Boda Christmas programme

Design:
Bertil Vallien

<p>97746-3 "Fågel" 1/kart. "Bird" 1/box H: 35 mm/1³/₈"</p> 	<p>97761-3 Fönstersmycke tomte i släde 1/kart. Window ornament, Father Christmas in his sleigh 1/box H: 305 mm/12"</p> 	<p>97762-3 Fönstersmycke tomte stående 1/kart. Window ornament Father Christmas standing 1/box H: 250 mm/9⁷/₈"</p> 	<p>97763-3 Tomte med julklappssäck för ljus 1/kart. Candleholder Father Christ- mas with sack of gifts 1/box H: 115 mm/4¹/₂"</p> 
<p>97764-3 Tomte "Nisse" 1/kart. Father Christmas "Nisse" 1/box H: 110 mm/4³/₈"</p> 	<p>97766-3 Adventsljusstake bock 1/kart. Adventholder goat 1/box L: 335 mm/13¹/₈"</p> 	<p>97767-3 Adventsljusstake tomte i släde 1/kart. Adventholder Father Christ- mas in his sleigh 1/box L: 290 mm/11³/₈"</p> 	<p>97768-3 Julgranssmycke äpple 1/kart. Christmas tree decoration apple 1/box H: 60 mm/2³/₈"</p> 
<p>97769-3 Julgranssmycke ren 1/kart. Christmas tree decoration reindeer 1/box H: 55 mm/2¹/₈"</p> 	<p>97770-3 Julgranssmycke tomte i släde 1/kart. Christmas tree decoration Father Christmas in his sleigh 1/box H: 75 mm/3"</p> 	<p>97856-3 Julgranssmycke "Tomte" 1/kart. Christmas tree decoration "Father Christmas" 1/box</p> 	<p>97857-3 Julgranssmycke "Ängel" 1/kart. Christmas tree decoration "Angel" 1/box</p> 
<p>97858-3 Julgranssmycke "Trumpet" 1/kart. Christmas tree decoration "Trumpet" 1/box</p> 			

Boda Krinolin Boda Crinoline

Design:
Monica Backström



48155-2
Vas på fot rosa
Vase ftd pink
H: 160 mm/6 1/4"

48165-2
Vas på fot blå
Vase ftd blue
H: 160 mm/6 1/4"



48156-2
Vas på fot rosa
Vase ftd pink
H: 200 mm/7 7/8"

48166-2
Vas på fot blå
Vase ftd blue
H: 200 mm/7 7/8"



58158-2
Skål på fot rosa
Bowl ftd pink
H: 90 mm/3 1/2"
Ø: 110 mm/4 3/8"

58168-2
Skål på fot blå
Bowl ftd blue
H: 90 mm/3 1/2"
Ø: 110 mm/4 3/8"



58159-2
Skål på fot rosa
Bowl ftd pink
H: 130 mm/5 1/8"
Ø: 160 mm/6 1/4"

58169-2
Skål på fot blå
Bowl ftd blue
H: 130 mm/5 1/8"
Ø: 160 mm/6 1/4"



68156-2
Ljusstake rosa
Candlestick pink
H: 200 mm/7 7/8"

68166-2
Ljusstake blå
Candlestick blue
H: 200 mm/7 7/8"



78155-2
Fat på fot rosa
Dish ftd pink
H: 80 mm/3 1/8"
Ø: 200 mm/7 7/8"

78165-2
Fat på fot blå
Dish ftd blue
H: 80 mm/3 1/8"
Ø: 200 mm/7 7/8"



Boda Oktav Boda Octave

Design:
Bertil Vallien



97794-3
Tumbler 35 cl 2/kart.
Tumbler 12³/₁₀ oz 2/box
H: 85 mm/3³/₈"
Ø: 80 mm/3¹/₈"

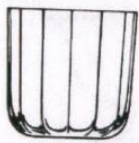

97827-3
OF 20 cl 2/kart.
OF 7 oz 2/box
H: 80 mm/3¹/₈"
Ø: 70 mm/2³/₄"

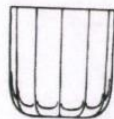

97793-3
Rödvin 35 cl 2/kart.
Redwine 12³/₁₀ oz 2/box
H: 170 mm/6⁵/₈"
Ø: 80 mm/3¹/₈"



97825-3
Vin 20 cl 2/kart.
Wine 7 oz 2/box
H: 160 mm/6¹/₄"
Ø: 70 mm/2³/₄"



97826-3
Champ.skål 2/kart.
Champ.bowl 2/box
H: 130 mm/5¹/₈"
Ø: 90 mm/3¹/₂"

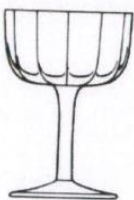

98008-3
Brännvin 2/kart.
Snaps 2/box
H: 120 mm/4³/₄"
Ø: 53 mm/2¹/₈"

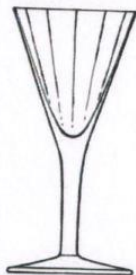

57843-3
Skål
Bowl
Ø: 120 mm/4³/₄"





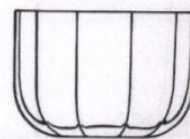



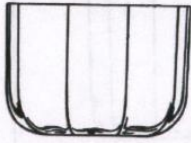
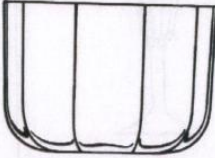

57792-3
Skål 1/kart.
Bowl 1/box
H: 85 mm/3³/₈"
Ø: 115 mm/4¹/₂"

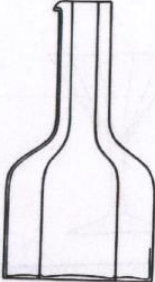
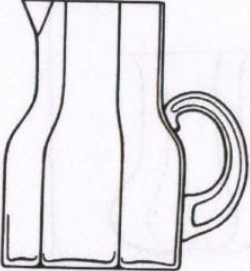
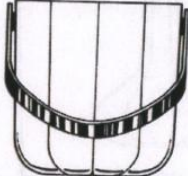
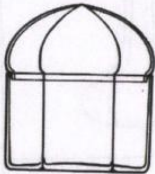



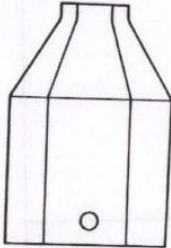
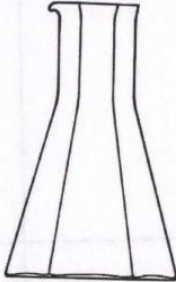
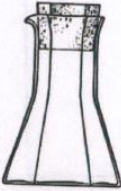
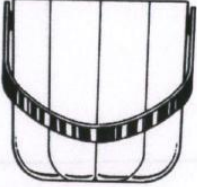
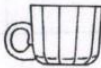







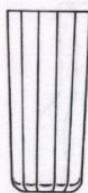

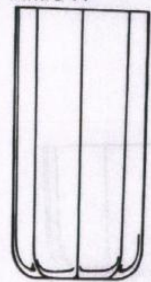
Design:
Bertil Vallien

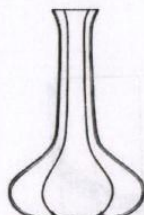
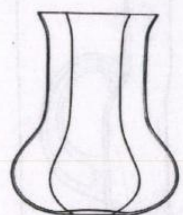
Boda Oktav Boda Octave

<p>57793-3 Skål 1/kart. Bowl 1/box H: 120 mm/4³/₄" Ø: 165 mm/6¹/₂"</p> 	<p>57794-3 Skål 1/kart. Bowl 1/box H: 145 mm/5³/₄" Ø: 190 mm/7¹/₂"</p> 	<p>87792-3 Karaff 32 cl 1/kart. Decanter 11³/₁₀ oz 1/box</p> 	<p>87793-3 Karaff 75 cl 1/kart. Decanter 26²/₅ oz 1/box</p> 
<p>87794-3 Kanna 1/kart. Jug 1/box H: 195 mm/7⁵/₈"</p> 	<p>97828-3 Ishink 1/kart. Icebucket 1/box H: 110 mm/4³/₈" Ø: 120 mm/4³/₄"</p> 	<p>97824-3 Bonbonjär 1/kart. Bonbon 1/box H: 120 mm/4³/₄" Ø: 90 mm/3¹/₂"</p> 	<p>67826-3 Ljusstake 1/kart. Candlestick 1/box H: 200 mm/7⁷/₈"</p> 
<p>97795-3 Salladsbestick Salad servers L: 260 mm/10¹/₄"</p> 	<p>67923-3 Lykta 1/kart. Hurricane lamp 1/box H: 115 mm/4¹/₂"</p> 	<p>67922-3 Lykta 1/kart. Hurricane lamp 1/box H: 220 mm/8⁵/₈"</p> 	<p>87922-3 Mixer 1/kart. Mixer 1/box H: 230 mm/9"</p> 
<p>97930-3 Dressingflaska 1/kart. Dressing bottle 1/box H: 145 mm/5³/₄"</p> 	<p>97929-3 Ishink 1/kart. Icebucket 1/box H: 140 mm/5¹/₂" Ø: 140 mm/5¹/₂"</p> 	<p>97926-3 Punsch 2/kart. Punsch 2/box H: 50 mm/2" Ø: 60 mm/2³/₈"</p> 	<p>97922-3 Sherry 2/kart. Sherry 2/box H: 125 mm/4⁷/₈" Ø: 50 mm/2"</p> 

Boda Oktav Boda Octave

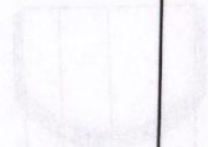
Design:
Bertil Vallien

<p>97923-3 Cocktail 2/kart. Cocktail 2/box H: 150 mm/5⁷/₈" Ø: 110 mm/4³/₈"</p> 	<p>97928-3 Grogg 2/kart. Highball 2/box H: 150 mm/5⁷/₈" Ø: 70 mm/2³/₄"</p> 	<p>97924-3 Champ. högt 2/kart. Champ. tall 2/box H: 215 mm/8¹/₂" Ø: 50 mm/2"</p> 	<p>47793-3 Vas 1/kart. Vase 1/box H: 195 mm/7⁵/₈" Ø: 95 mm/3³/₄"</p> 
<p>47982-3 Vas 1/kart. Vase 1/box H: 100 mm/4"</p> 	<p>47983-3 Vas 1/kart. Vase 1/box H: 150 mm/5⁷/₈"</p> 	<p>47984-3 Vas 1/kart. Vase 1/box H: 180 mm/7¹/₈"</p> 	<p>47985-3 Vas 1/kart. Vase 1/box H: 180 mm/7¹/₈"</p> 
			
			

Design:
Bertil Vallien

Boda Olympia



57931-3
Skål 1/kart.
Bowl 1/box
H: 105 mm/4¹/₈"
Ø: 200 mm/7⁷/₈"

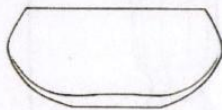

57932-3
Skål 1/kart.
Bowl 1/box
H: 130 mm/5¹/₈"
Ø: 240 mm/9¹/₂"



87931-3
Karaff 1/kart.
Decanter 1/box
H: 250 mm/9⁷/₈"



Boda Opalin

Design:
Monica Backström



58155-2
Skål rosa
Bowl pink
H: 80 mm/3 1/8"
Ø: 140 mm/5 1/2"

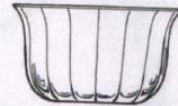

58156-2
Skål rosa
Bowl pink
H: 105 mm/4 1/8"
Ø: 185 mm/7 1/4"



58157-2
Skål rosa
Bowl pink
H: 130 mm/5 1/8"
Ø: 210 mm/8 1/4"

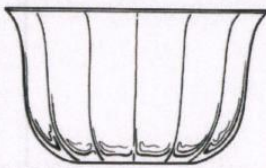

68155-2
Ljuslykta rosa
Candlebowl pink
H: 100 mm/4"



88155-2
Karaff 75 cl rosa
Decanter 26 oz pink
H: 245 mm/9 5/8"



98155-2
Vinglas 20 cl rosa
Wine glass 7 oz pink
H: 105 mm/4 1/8"



Boda Primula

**Design:
Kjell Engman**

44495-5
Vas 1/kart.
Vase 1/box
H: 125 mm/4 7/8"



44496-5
Vas 1/kart.
Vase 1/box
H: 175 mm/6 7/8"



44497-5
Vas 1/kart.
Vase 1/box
H: 235 mm/9 1/4"

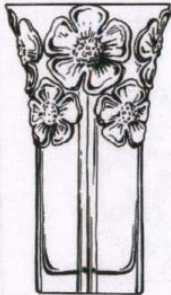

55495-5
Skål 1/kart.
Bowl 1/box
H: 105 mm/4 1/8"



55496-5
Skål 1/kart.
Bowl 1/box
H: 125 mm/4 7/8"



55497-5
Skål 1/kart.
Bowl 1/box
H: 155 mm/6 1/8"



66495-5
Ljuslykta 1/kart.
Candlebowl 1/box
H: 75 mm/3"



Boda Rapsodi Boda Rhapsody

Design:
Kjell Engman



47957-2
Vas rekt. 1/kart.
Vase rect. 1/box
H: 140 mm/5 1/2"



57837-2
Skål 1/kart.
Bowl 1/box
H: 105 mm/4 1/8"
Ø: 150 mm/5 7/8"



57838-2
Skål 1/kart.
Bowl 1/box
H: 140 mm/5 1/2"
Ø: 190 mm/7 1/2"



57839-2
Skål på fot 1/kart.
Bowl on foot 1/box
H: 125 mm/4 7/8"
Ø: 110 mm/4 3/8"



57920-2
Skål 1/kart.
Bowl 1/box
H: 80 mm/3 1/8"
Ø: 100 mm/4"



78020-2
Fat 1/kart.
Dish 1/box
Ø: 290 mm/11 3/8"

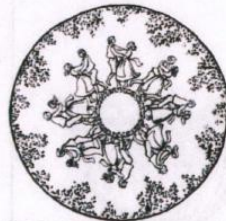

78021-2
Fat
Dish
Ø: 340 mm/13 3/8"



87839-2
Karaff 75 cl 1/kart.
Decanter 26 2/5 oz 1/box
H: 215 mm/8 1/2"



97883-2
Snaps 2/kart.
Snaps 2/box
H: 105 mm/4 1/8"



Boda – Reijmyre – figurer block

39001-5
 Elefant 1/kart.
 Elephant 1/box
 H: 90 mm/3 1/2"



39002-5
 Pingvin 1/kart.
 Penguin 1/box
 H: 140 mm/5 1/2"

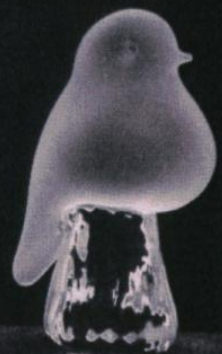
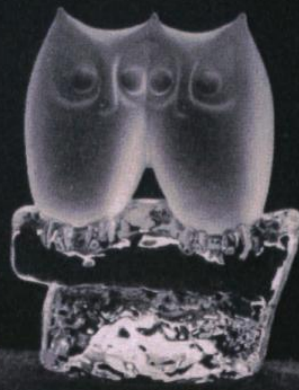

39003-5
 Uggla 1/kart.
 Owl 1/box
 H: 75 mm/3"



39004-5
 Snigel 1/kart.
 Smail 1/box
 H: 60 mm/2 3/8"



39005-5
 Isbjörn 1/kart.
 Polar bear 1/box
 H: 65 mm/2 1/2"



39007-5
 Uggla 1/kart.
 Owl 1/box
 H: 95 mm/3 3/4"



39008-5
 Turturduva 1/kart.
 Turtle-dove 1/box
 H: 130 mm/5 1/8"



39009-5
 Fågel 1/kart.
 Bird 1/box
 H: 120 mm/4 3/4"

















39010-5
 Isbjörn 1/kart.
 Polar bear 1/box
 H: 120 mm/4 3/4"



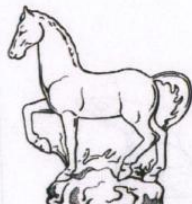













39012-5
 Fågel 1/kart.
 Bird 1/box
 H: 95 mm/3 3/4"

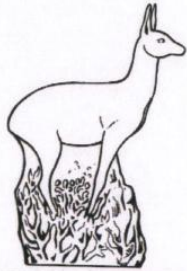

Boda – Reijmyre – figurer block

<p>39013-5 Turturduva 1/kart. Turtle-dove 1/box H: 75 mm/3"</p> 	<p>39014-5 Delfin 1/kart. Dolphin 1/box H: 150 mm/5 7/8"</p> 	<p>39015-5 Fågel 1/kart. Bird 1/box H: 90 mm/3 1/2"</p> 	<p>39017-5 Nattugglor 1/kart. Owls 1/box H: 100 mm/4"</p> 
<p>39018-5 Delfin 1/kart. Dolphin 1/box H: 115 mm/4 1/2"</p> 	<p>39025-5 Sjöjungfru 1/kart. Mermaid 1/box H: 205 mm/8"</p> 	<p>39026-5 Häst huvud 1/kart. Horse head 1/box H: 125 mm/4 7/8"</p> 	<p>39027-5 Häst 1/kart. Horse 1/box H: 165 mm/6 1/2"</p> 
<p>39028-5 Björn 1/kart. Bear 1/box H: 100 mm/4"</p> 	<p>39030-5 Häst 1/kart. Horse 1/box H: 135 mm/5 3/8"</p> 	<p>39031-5 Snögubbe 1/kart. Snowman 1/box H: 105 mm/4 1/8"</p> 	<p>39032-5 Snögubbe 1/kart. Snowman 1/box H: 135 mm/5 3/8"</p> 
<p>39034-5 Ekorre 1/kart. Squirrel 1/box H: 115 mm/4 1/2"</p> 	<p>39035-5 Nattugglor 1/kart. Owls 1/box H: 115 mm/4 1/2"</p> 	<p>39037-5 Valp 1/kart. Dog 1/box H: 90 mm/3 1/2"</p> 	<p>39038-5 Gran 1/kart. Spruce 1/box H: 180 mm/7 1/8"</p> 

Boda – Reijmyre – figurer block

<p>39041-5 Fågel 1/kart. Bird 1/box H: 80 mm/3 1/8"</p> 	<p>39044-5 Fågel 1/kart. Bird 1/box H: 70 mm/2 3/4"</p> 	<p>39052-5 Rådjur 1/kart. Roe 1/box H: 125 mm/4 7/8"</p> 	<p>39053-5 Fågel 1/kart. Bird 1/box H: 135 mm/5 3/8"</p> 
<p>39054-5 Fågel 1/kart. Bird 1/box H: 140 mm/5 1/2"</p> 	<p>39071-5 Fågel 1/kart. Bird 1/box H: 110 mm/4 3/8"</p> 	<p>39072-5 Hund 1/kart. Dog 1/box H: 135 mm/5 3/8"</p> 	<p>39080-5 Rådjur 1/kart. Roe 1/box H: 175 mm/6 7/8"</p> 
<p>39081-5 Havsfrue 1/kart. Havsfrue 1/box H: 125 mm/4 7/8"</p> 	<p>39095-5 Örn 1/kart. Eagle 1/box H: 165 mm/6 1/2"</p> 	<p>39100-5 Block Varg 1/kart. Block Wolf 1/box 125 x 165 mm/4 7/8 x 6 1/2"</p> 	<p>39101-5 Block Örn 1/kart. Block Eagle 1/box 140 x 135 mm/5 1/2 x 5 3/8"</p> 
<p>39102-5 Block Rådjur 1/kart. Block Roe Deer 1/box 125 x 150 mm/4 7/8 x 5 7/8"</p> 	<p>39103-5 Block Älg 1/kart. Block Moose 1/box 120 x 160 mm/4 3/4 x 6 1/4"</p> 	<p>39104-5 Block Isbjörn 1/kart. Block Polar bear 1/box 130 x 160 mm/5 1/8 x 6 1/4"</p> 	<p>39105-5 Block Ekor'n satt i granen 1/kart. Block Squirrel 1/box 130 x 175 mm/5 1/8 x 6 7/8"</p> 

Boda – Reijmyre – figurer block

39106-5
Block Små grodorna 1/kart.
Block Frogs 1/box
165 x 150 mm/6 1/2 x 5 7/8"



39107-5
Block Lasse, Lasse liten
1/kart.
Block Boy 1/box
175 x 145 mm/6 7/8 x 5 3/4"



39108-5
Block Mors lilla Olle 1/kart.
Block Boy 1/box
135 x 175 mm/5 3/8 x 6 7/8"



39109-5
Block Bä, bä vita lamm 1/kart.
Block Lamb 1/box
155 x 150 mm/6 1/8 x 5 7/8"



Design:
Ulrica
Hydman-Vallien

Boda Romantica

47992-3
Vas orkidé 1/kart.
Vase orchid 1/box
H: 200 mm/7⁷/₈"



57970-3
Skål 1/kart.
Bowl 1/box
H: 80 mm/3¹/₈"
Ø: 115 mm/4¹/₂"



57971-3
Skål på fot 1/kart.
Bowl on foot 1/box
H: 160 mm/6¹/₄"
Ø: 140 mm/5¹/₂"



57992-3
Skål 1/kart.
Bowl 1/box
H: 120 mm/4³/₄"
Ø: 180 mm/7¹/₈"



87970-3
Karaff 75 cl 1/kart.
Decanter 26²/₅ oz 1/box
H: 260 mm/10¹/₄"



97969-3
Sherry 7¹/₂ cl 1/kart.
Wine 2³/₅ oz 1/box
H: 160 mm/6¹/₄"
Ø: 70 mm/2³/₄"



97970-3
Vitvin 15 cl 1/kart.
Wine 5³/₁₀ oz 1/box
H: 190 mm/7¹/₂"
Ø: 90 mm/3¹/₂"



97971-3
Rödvin 25 cl 1/kart.
Wine 8⁴/₅ oz 1/box
H: 225 mm/8⁷/₈"
Ø: 100 mm/4"



97992-3
Champ. hög 1/kart.
Champ. tall 1/box
H: 225 mm/8⁷/₈"



Boda Seafood

Design:
Paul Hoff

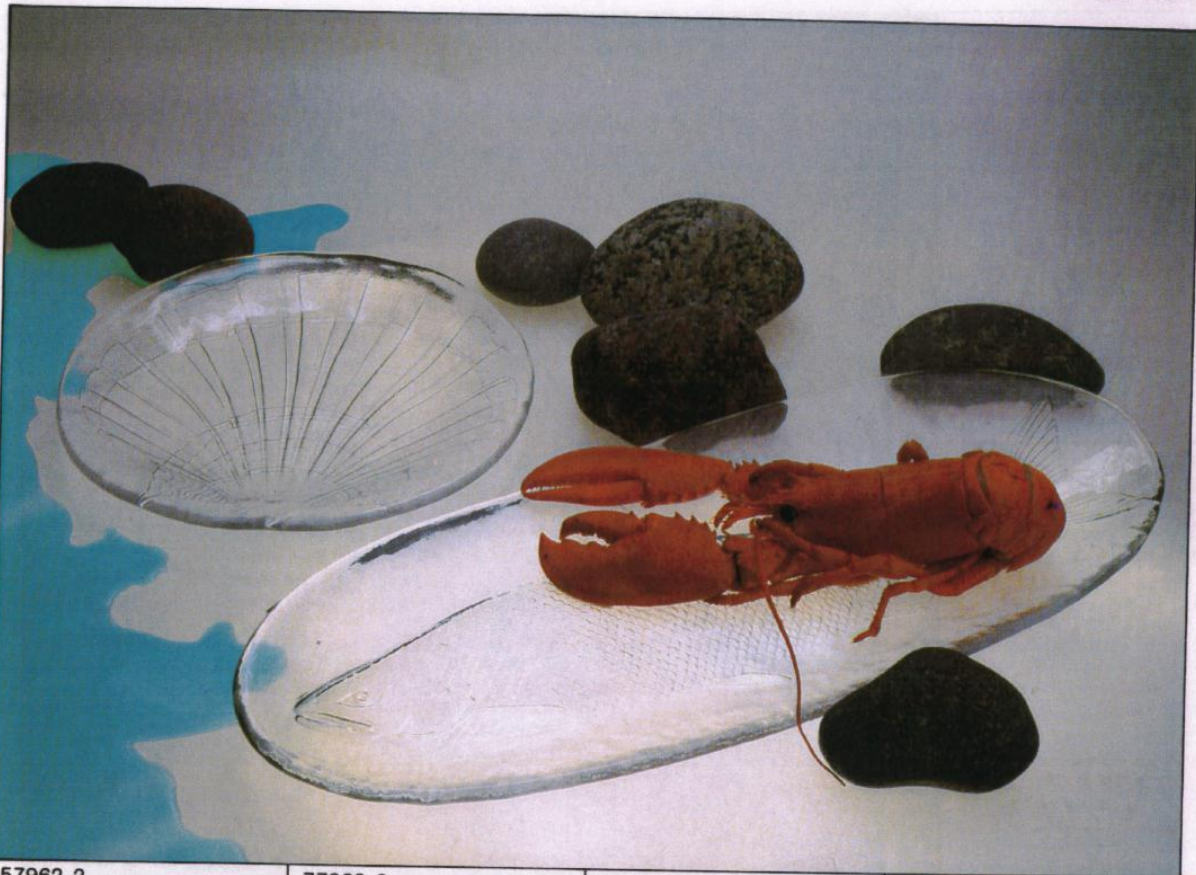

57962-2
Skål 1/kart.
Bowl 1/box
H: 140 mm/5¹/₂"
Ø: 210 mm/8¹/₄"



77962-2
Räktallrik 2/kart.
Shrimp plate 2/box
Ø: 235 mm/9¹/₄"



77963-2
Sillfat 1/kart.
Herring dish 1/box
Ø: 300x125 mm/
11³/₄"x4⁷/₈"

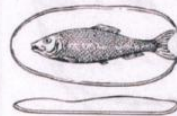

77964-2
Hummerfat 1/kart.
Lobster dish 1/box
Ø: 350x240 mm/
13³/₄"x9¹/₂"

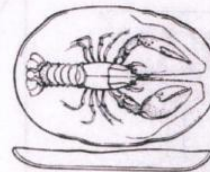

77965-2
Laxfat 1/kart.
Salmon dish 1/box
L: 500 mm/19³/₄"

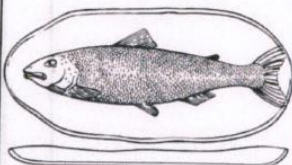

77967-2
Tallrik "Snäcka" 2/kart.
Plate "Shell" 2/box
Ø: 260 mm/10¹/₄"

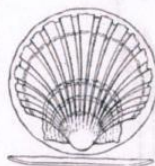

Boda Sweden

Design:
Kjell Engman

48112-2
Vas 1/kart.
Vase 1/box
H: 160 mm/6 1/4"



58112-2
Skål 1/kart.
Bowl 1/box
Ø: 140 mm/5 1/2"
H: 115 mm/4 1/2"

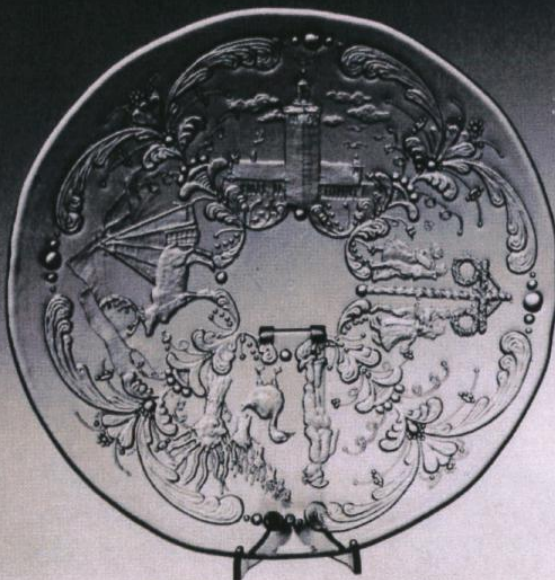

78112-2
Fat 1/kart.
Dish 1/box
Ø: 290 mm/11 3/8"

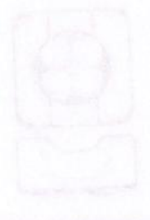
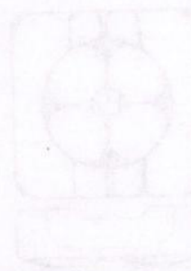

Boda Tulip

Design:
Rolf Sinnemark



67708-2
Ljusstake 1/kart.
Candlestick 1/box
H: 75 mm/3"

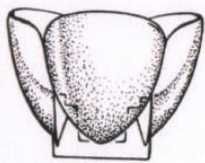

67709-2
Ljusstake 1/kart.
Candlestick 1/box
H: 95 mm/3³/₄"



67710-2
Ljuslykta 1/kart.
Hurricane lamp 1/box
H: 110 mm/4³/₈"

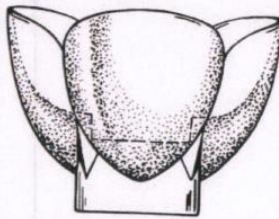

67711-2
Ljusstake 1/kart.
Candlestick 1/box
H: 140 mm/5¹/₂"



67751-2
Ljusstake 1/kart.
Candlestick 1/box
H: 45 mm/1³/₄"



77810-2
Askfat fyrkantig 1/kart.
Ashtray square 1/box
Ø: 85 mm/3³/₈"



77811-2
Askfat fyrkantig 1/kart.
Ashtray square 1/box
Ø: 120 mm/4³/₄"

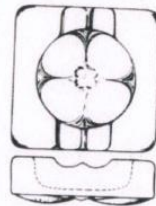

77812-2
Askfat fyrkantig 1/kart.
Ashtray square 1/box
Ø: 160 mm/6¹/₄"

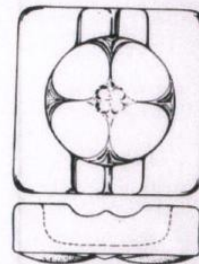







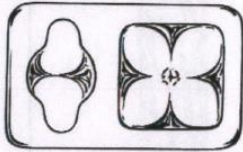

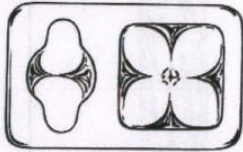
Design:
Rolf Sinnemark

Boda Tulip

77813-2
Pipaskfat 1/kart.
Pipeashtray 1/box
175 x 105 mm / 6 7/8" x 4 1/8"

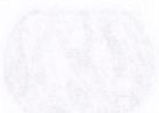

Boda Zelda

Design:
Monica Backström

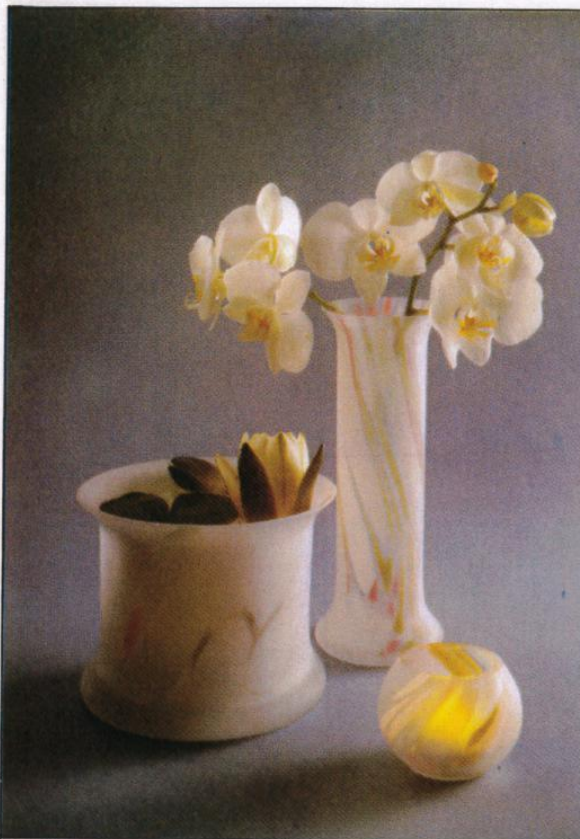

47595-2
Vas
Vase
H: 150 mm/5⁷/₈"
Ø: 75 mm/3"



47538-2
Vas
Vase
H: 240 mm/9¹/₂"
Ø: 80 mm/3¹/₈"



47539-2
Vas
Vase
H: 240 mm/9¹/₂"
Ø: 155 mm/6¹/₈"



57538-2
Skål
Bowl
H: 100 mm/4"
Ø: 110 mm/4³/₈"



57539-2
Skål
Bowl
H: 140 mm/5¹/₂"
Ø: 165 mm/6¹/₂"



57595-2
Skål på fot
Bowl on foot
H: 120 mm/4³/₄"
Ø: 130 mm/5¹/₈"



57596-2
Skål på fot
Bowl on foot
H: 160 mm/6¹/₄"
Ø: 180 mm/7¹/₈"



67541-2
Ljuslykta 1/kart.
Hurricane lamp 1/box
H: 50 mm/2"
Ø: 85 mm/3³/₈"



67538-2
Ljuslykta 1/kart.
Hurricane lamp 1/box
H: 70 mm/2³/₄"
Ø: 115 mm/4¹/₂"



Design:
Bertil Vallien

Boda Zoo



97515-3
Simmande flodhäst 1/kart.
Swimming hippopotamus
1/box
L: 190 mm/7¹/₂"



97611-3
Flodhäst 1/kart.
Hippopotamus 1/box
H: 60 mm/2³/₈"



97612-3
Häst 1/kart.
Horse 1/box
H: 130 mm/5¹/₂"



97613-3
Elefant 1/kart.
Elephant 1/box
H: 100 mm/4"



97614-3
Elefant 1/kart.
Elephant 1/box
H: 140 mm/5¹/₂"



97617-3
Lejon 1/kart.
Lion 1/box
H: 70 mm/2³/₄"



97618-3
Lejon 1/kart.
Lion 1/box
H: 100 mm/4"











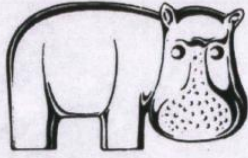





97620-3
Åsna 1/kart.
Donkey 1/box
H: 100 mm/4"







Boda Zoo

Design:
Bertil Vallien

<p>97667-3 Ren 1/kart. Reindeer 1/box H: 130 mm/5¹/₈"</p> 	<p>97698-3 Flodhäst 1/kart. Hippopotamus 1/box H: 140 mm/5¹/₂"</p> 	<p>97699-3 Lejon 1/kart. Lion 1/box H: 160 mm/6¹/₄" L: 250 mm/9⁷/₈"</p> 	<p>97701-3 Simmande flodhäst Swimming hippopotamus L: 130 mm/5¹/₈"</p> 
<p>97714-3 Uggla liten 1/kart. Owl small 1/box H: 75 mm/3"</p> 	<p>97715-3 Uggla stor 1/kart. Owl large 1/box H: 120 mm/4³/₄"</p> 	<p>97751-3 Katt liten 1/kart. Cat small 1/box H: 85 mm/3³/₈"</p> 	<p>97752-3 Katt stor 1/kart. Cat large 1/box H: 145 mm/5³/₄"</p> 
<p>97753-3 Giraff liten 1/kart. Giraffe small 1/box H: 175 mm/6⁷/₈"</p> 	<p>97754-3 Giraff stor 1/kart. Giraffe large 1/box H: 235 mm/9¹/₄"</p> 	<p>97829-3 Krokodil 1/kart. Crocodile 1/box L: 210 mm/8¹/₄"</p> 	<p>97841-3 Sköldpadda 1/kart. Turtle 1/box H: 40 mm/1¹/₂" L: 115 mm/4¹/₂"</p> 
<p>97848-3 Groda 1/kart. Frog 1/box H: 65 mm/2¹/₂" L: 120 mm/4³/₄"</p> 	<p>97847-3 Enhörning 1/kart. Unicorn 1/box H: 130 mm/5¹/₈" L: 145 mm/5³/₄"</p> 	<p>97940-3 Apa 1/kart. Monkey 1/box H: 100 mm/4"</p> 	<p>97941-3 Tiger 1/kart. Tiger 1/box H: 100 mm/4" L: 140 mm/5¹/₂"</p> 

**Design:
Bertil Vallien**

Boda Zoo

<p>97942-3 Groda 1/kart. Frog 1/box H: 50 mm/2" L: 85 mm/3³/₈"</p> 	<p>97943-3 Kamel 1/kart. Camel 1/box H: 105 mm/4¹/₈" L: 140 mm/5¹/₂"</p> 	<p>97944-3 Pingvin 1/kart. Penguin 1/box H: 115 mm/4¹/₂"</p> 	<p>97945-3 Känguru 1/kart. Kangaroo 1/box H: 125 mm/4⁷/₈"</p> 
<p>97946-3 Björn 1/kart. Bear 1/box H: 75 mm/3"</p> 			





Vaser
Vases



Crystal



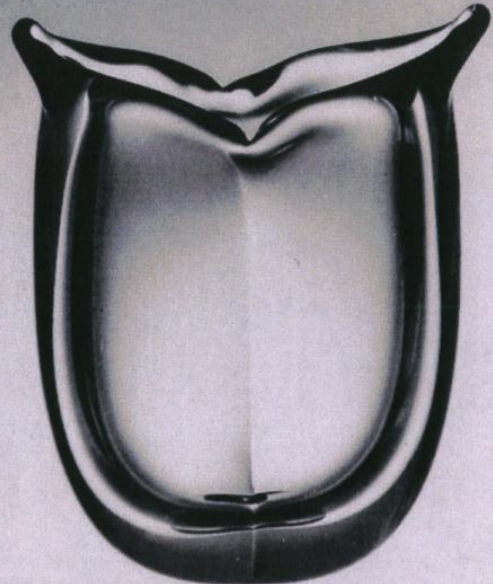
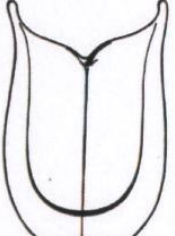

**Design:
Göran Wärff**

Kosta Amorina

<p>47807-1 Vas 1/kart. Vase 1/box H: 165 mm/6 1/2"</p> 	<p>47808-1 Vas Vase H: 185 mm/7 1/4"</p> 	
<p>47809-1 Vas Vase H: 220 mm/8 5/8"</p> 		

Crystal

**Design:
Göran Wärff**

<p>47900-1 Vas Vase H: 205 mm/8"</p> 		
		

Kosta Arkad

Crystal

Design:
Bengt Edenfalk

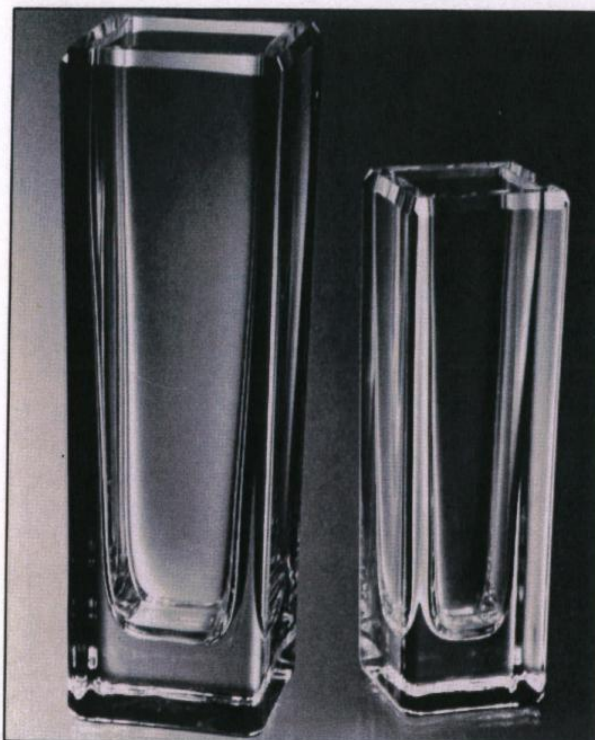

44263-5
Vas
Vase
H: 210 mm/8 1/4"

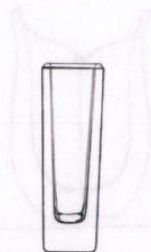

44264-5
Vas
Vase
H: 170 mm/6 5/8"

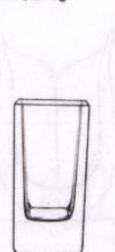

44265-5
Vas
Vase
H: 255 mm/10"



Kosta Carlton

Crystal

Design:
Bengt Edenfalk



44500-5
Vas
Vase
H: 175 mm/6 7/8"



44501-5
Vas
Vase
H: 200 mm/7 7/8"

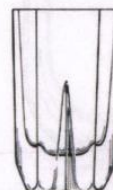

44502-5
Vas
Vase
H: 225 mm/8 7/8"

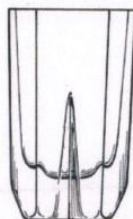



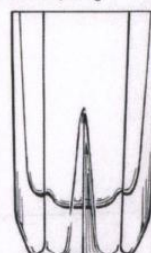

44503-5
Vas
Vase
H: 250 mm/9 7/8"

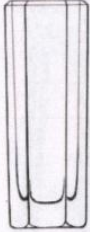

Crystal

**Design:
Bengt Edenfalk**





Kosta Colonna

<p>44268-5 Vas Vase H: 180 mm/7 1/8"</p> 	<p>44269-5 Vas Vase H: 220 mm/8 5/8"</p> 	
<p>44270-5 Vas Vase H: 190 mm/7 1/2"</p> 	<p>44271-5 Vas Vase H: 165 mm/6 1/2"</p> 	

Crystal

**Design:
Bengt Edenfalk**

Kosta Dukat

<p>44221-5 Vas Vase H: 145 mm/5 3/4"</p> 	<p>44222-5 Vas Vase H: 190 mm/7 1/2"</p> 	
<p>44223-5 Vas Vase H: 215 mm/8 1/2"</p> 		

Crystal

Design:
Vicke Lindstrand

41011-1
Flaskvas med luftblåsor
Vase with bubbles
H: 300 mm/11³/₄"

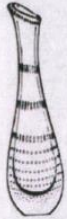

41331-1
Flaskvas med luftblåsor
Vase with bubbles
H: 230 mm/9"



Kosta Dagdroppe Kosta Dewdrop

47831-1
Vas 1/kart.
Vase 1/box
H: 160 mm/6¹/₄"



Crystal

**Design:
Bengt Edenfalk**

Kosta EKB

44291-5
Vas
Vase
H: 185 mm/7 1/4"



44292-5
Vas
Vase
H: 210 mm/8 1/4"

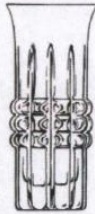

44293-5
Vas
Vase
H: 250 mm/9 7/8"

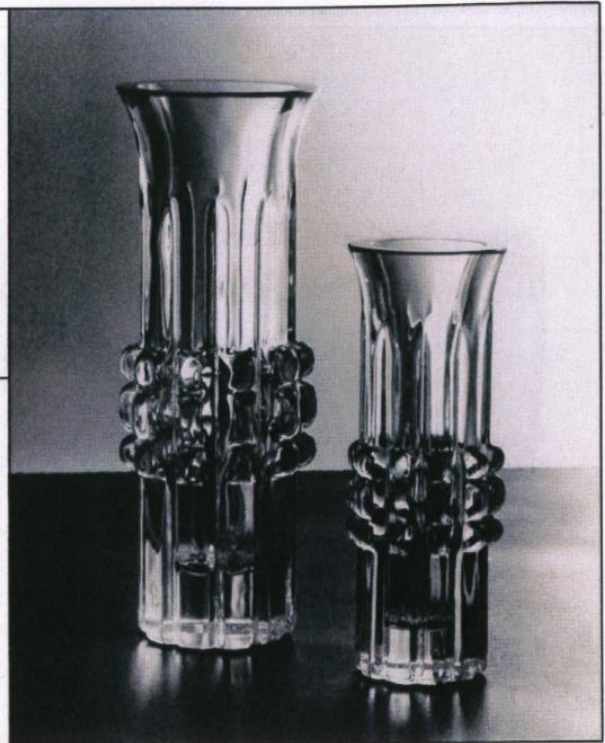
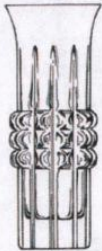

Crystal

**Design:
Bengt Edenfalk**

Kosta EMB

44298-5
Vas
Vase
H: 205 mm/8"



44299-5
Vas
Vase
H: 260 mm/10 1/4"

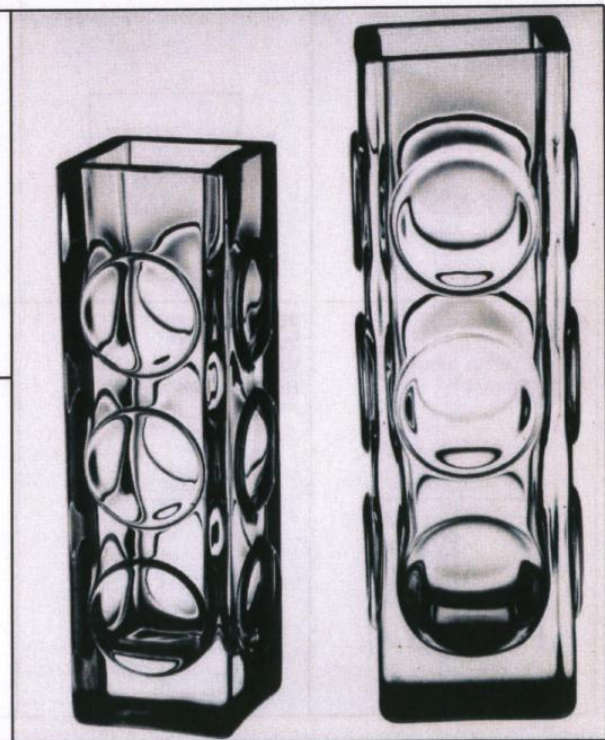

Crystal

Design:
Bengt Edenfalk

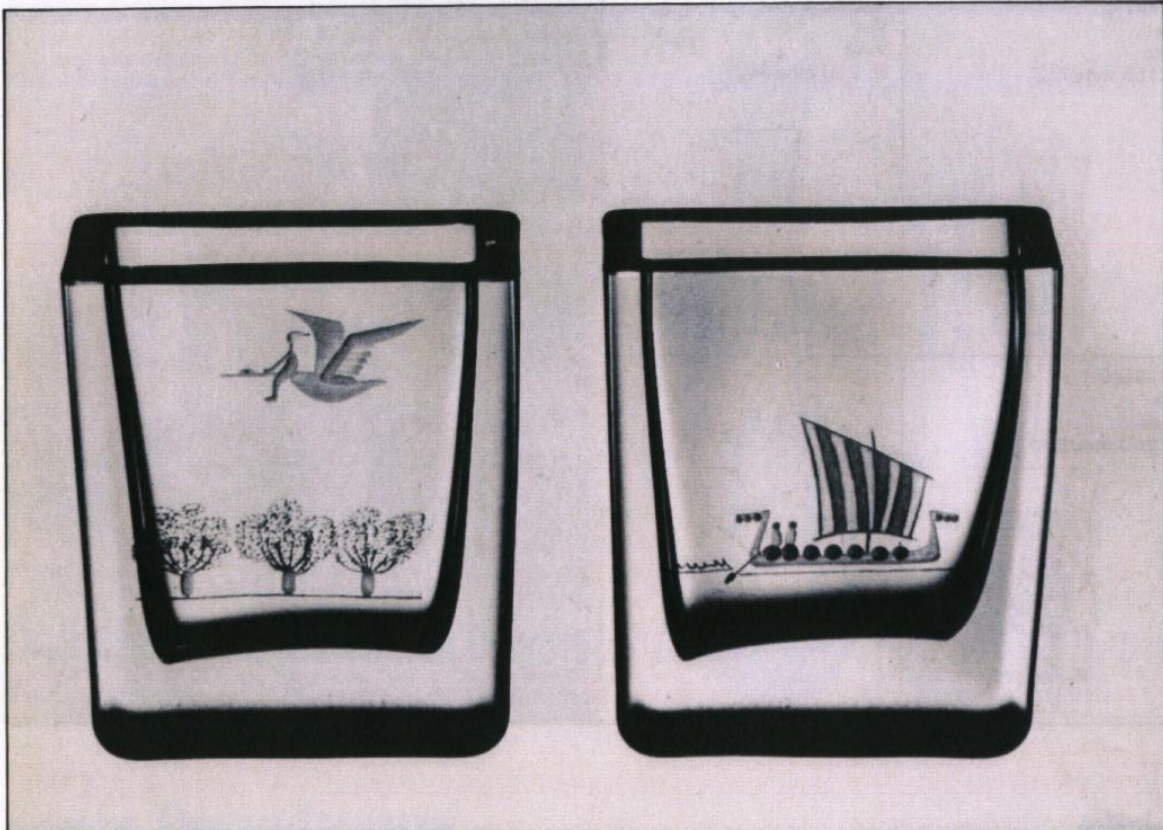

48070-1
Vas Nils Holgerson rekt.
Vase Nils Holgerson rect.
H: 115 mm/4 1/2"



48071-1
Vas Vikingskepp rekt.
Vase Viking ship rect.
H: 115 mm/4 1/2"

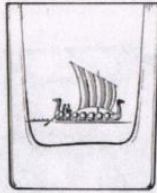

48072-1
Vas Swan 6-kt
Vase Swan hexagonal
H: 115 mm/4 1/2"



48073-1
Vas Anka 6-kt
Vase Duck hexagonal
H: 115 mm/4 1/2"

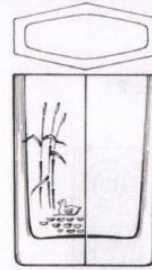

48074-1
Vas 2 Ankor 6-kt
Vase 2 Ducks hexagonal
H: 120 mm/4 3/4"

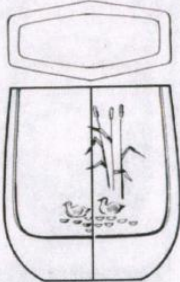

48075-1
Vas Mås 6-kt
Vase Seagull hexagonal
H: 120 mm/4 3/4"



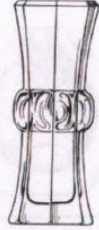
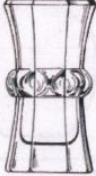
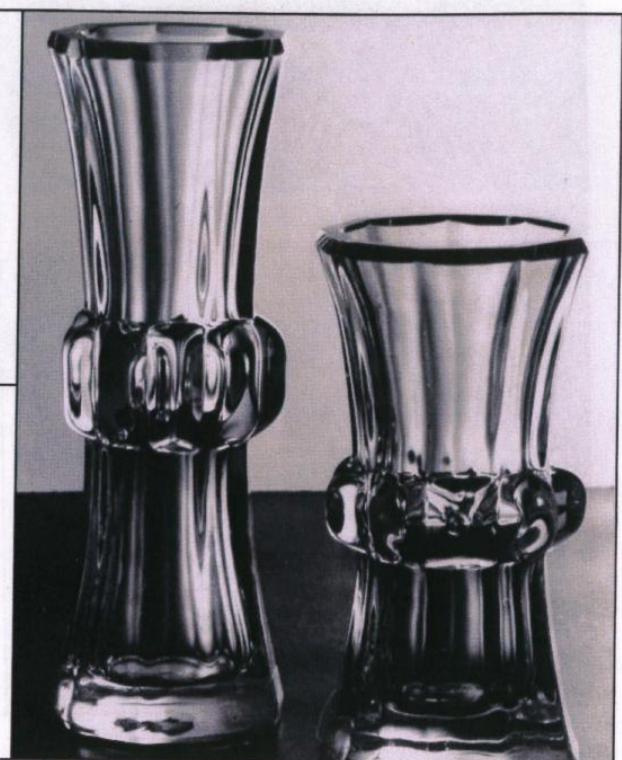
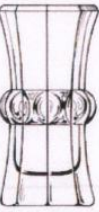
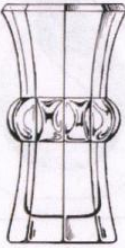

Crystal

**Design:
Bengt Edenfalk**

<p>44414-5 Vas Vase H: 210 mm/8 1/4"</p> 	<p>44415-5 Vas Vase H: 160 mm/6 1/4"</p> 	
<p>44416-5 Vas Vase H: 185 mm/7 1/4"</p> 	<p>44417-5 Vas Vase H: 220 mm/8 5/8"</p> 	

Crystal

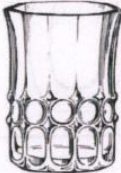
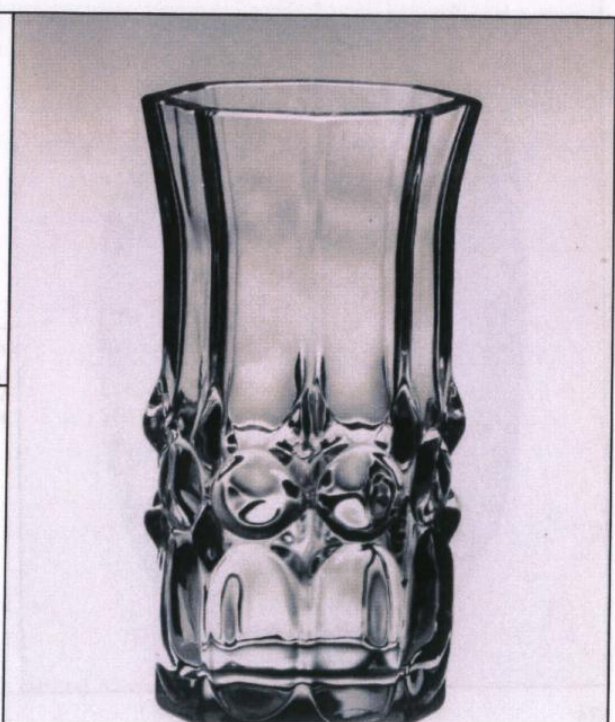

**Design:
Bengt Edenfalk**

<p>48119-1 Vas Vase H: 180 mm/7 1/8"</p> 	<p>48120-1 Vas vid Vase wide H: 190 mm/7 1/2"</p> 	
<p>48121-1 Vas Vase H: 200 mm/7 7/8"</p> 		

Kosta Inside

Crystal

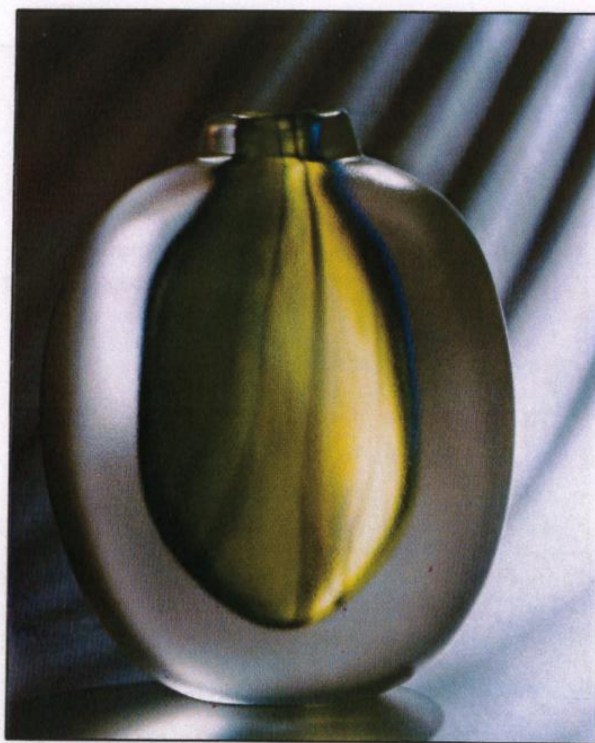

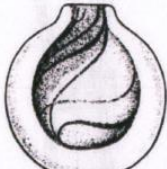
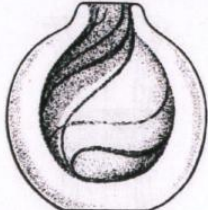
Design:
Göran Wärff

	<p>47923-1 Vas röd Vase red H: 100 mm/4"</p> 	<p>47924-1 Vas grön Vase green H: 130 mm/5 1/8"</p> 
	<p>47925-1 Vas grön Vase green H: 165 mm/6 1/2"</p> 	

Kosta Neptun

Crystal

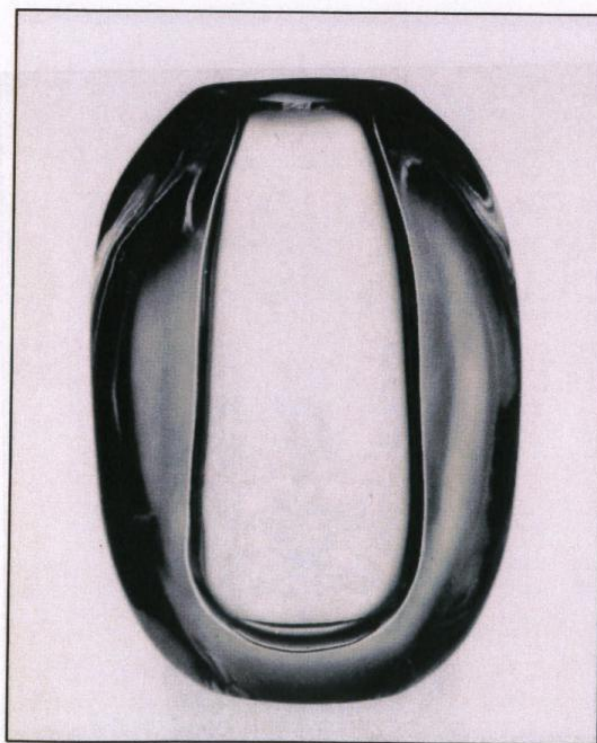
Design:
Göran Wärff

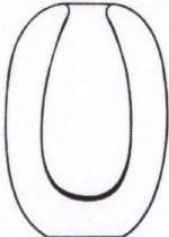
	<p>47814-1 Vas 1/kart. Vase 1/box H: 130 mm/5 1/8"</p> 	<p>47815-1 Vas Vase H: 180 mm/7 1/8"</p> 
	<p>47816-1 Vas Vase H: 220 mm/8 5/8"</p> 	

Kosta Pippi

46244-1
 Vas "Pippi" rund
 Vase "Pippi" round
 H: 155 mm/6¹/₈"



46245-1
 Vas "Pippi" rund 1/kart.
 Vase "Pippi" round 1/box
 H: 195 mm/7⁵/₈"



45712-1
 Vas "Pippi" rund
 Vase "Pippi" round
 H: 220 mm/8⁵/₈"



47614-1
 Vas "Pippi" fyrkantig 1/kart.
 Vase "Pippi" square 1/box
 H: 170 mm/6⁵/₈"

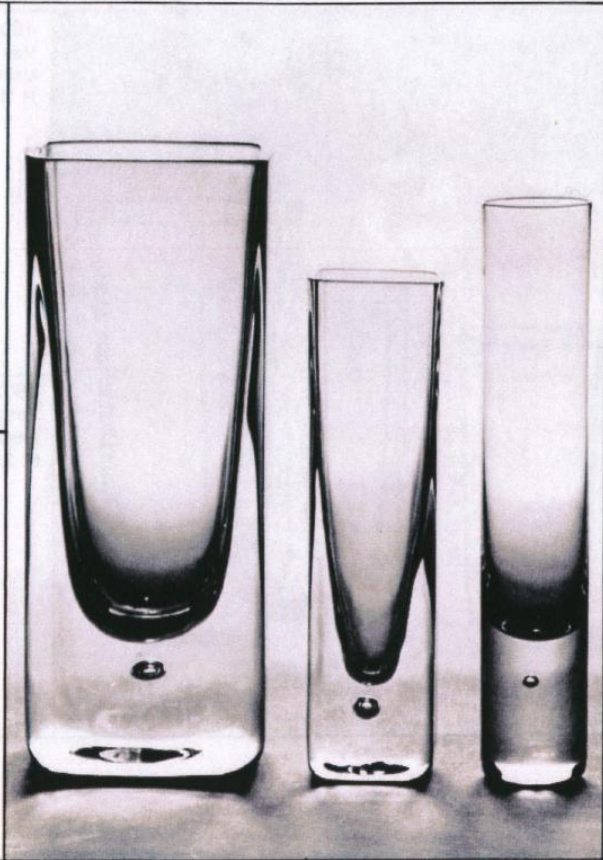

47615-1
 Vas "Pippi" fyrkantig
 Vase "Pippi" square
 H: 190 mm/7¹/₂"



47616-1
 Vas "Pippi" fyrkantig
 Vase "Pippi" square
 H: 205 mm/8"



47714-1
 Vas "Pippi" fyrkantig 1/kart.
 Vase "Pippi" square 1/box
 H: 220 mm/8⁵/₈"

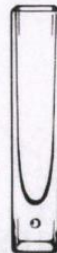

Kosta Palace

Crystal

Design:
Bengt Edenfalk

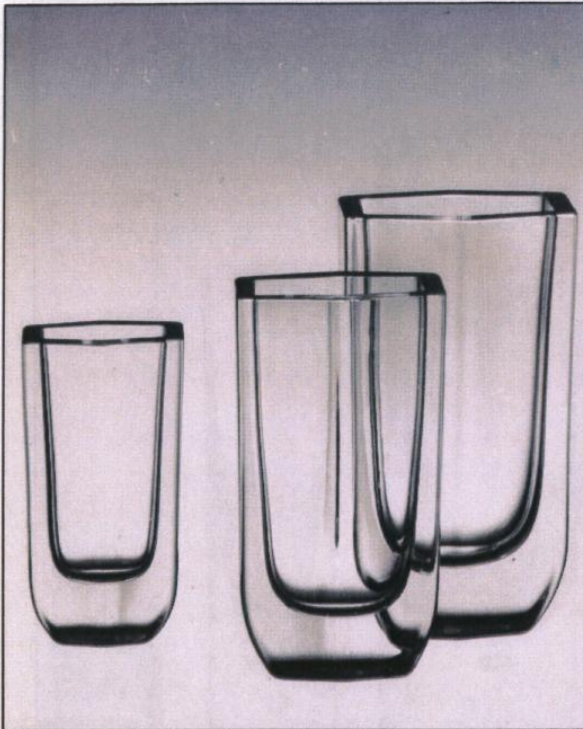

48021-1
Vas 6-kt
Vase hexagonal
H: 165 mm/6 1/2"



48022-1
Vas 6-kt
Vase hexagonal
H: 210 mm/8 1/4"



48023-1
Vas 6-kt
Vase hexagonal
H: 235 mm/9 1/4"

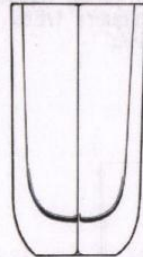

Crystal

Design:
Bengt Edenfalk

Kosta Pyramid

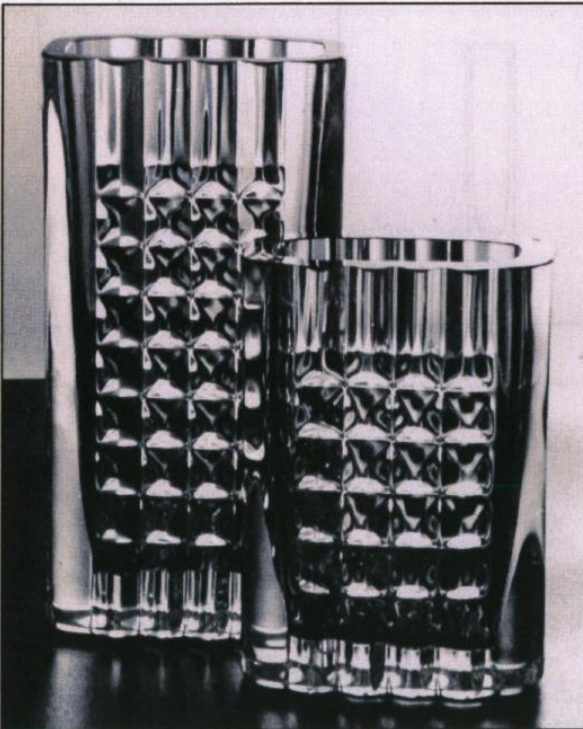

44212-5
Vas
Vase
H: 140 mm/5 1/2"

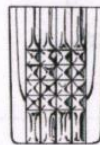

44213-5
Vas
Vase
H: 155 mm/6 1/8"

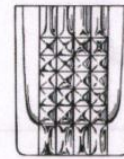

44214-5
Vas
Vase
H: 190 mm/7 1/2"

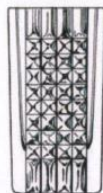

44215-5
Vas
Vase
H: 205 mm/8"

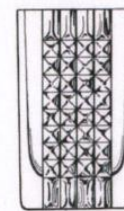

Design:
Sigurd Persson

Kosta Queen

47505-1
Vas 1/kart.
Vase 1/box
H: 200 mm/7 7/8"



Crystal

Design:
Bengt Edenfalk

Kosta Ritz

48024-1
Vas 8-kt
Vase octagonal
H: 165 mm/6 1/2"



48025-1
Vas 8-kt
Vase octagonal
H: 195 mm/7 5/8"



48026-1
Vas 8-kt
Vase octagonal
H: 225 mm/8 7/8"



Kosta Regndroppe Kosta Raindrop

Crystal

Design:
Göran Wärff

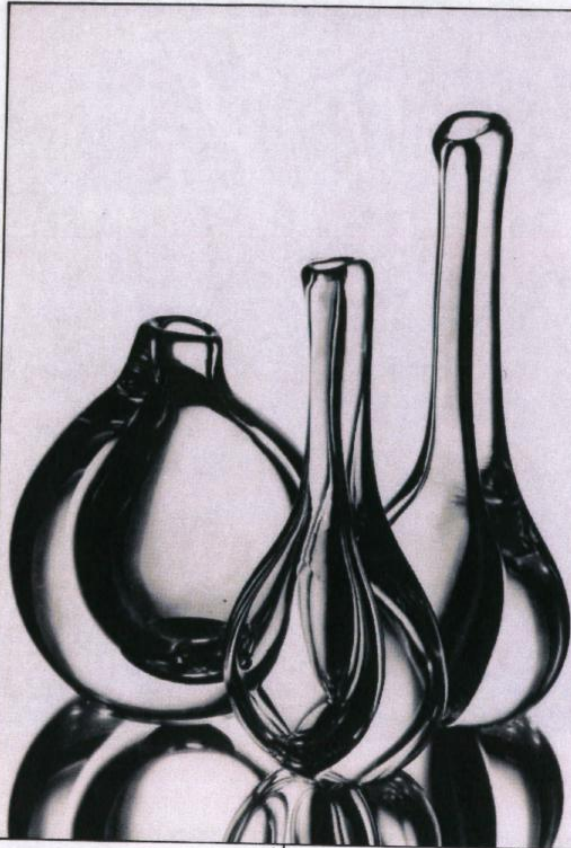

47800-1
Orkidévas 1/kart.
Budvase 1/box
H: 215 mm/8¹/₂"

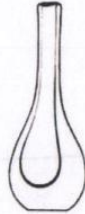

47801-1
Orkidévas
Budvase
H: 275 mm/10⁷/₈"



47802-1
Vas 1/kart.
Vase 1/box
H: 140 mm/5¹/₂"



47803-1
Vas
Vase
H: 185 mm/7¹/₄"



47904-1
Orkidévas
Budvase
H: 250 mm/9⁷/₈"



Kosta Rondo orkide Kosta Rondo orchid

Design:
Wärff

47600-1
Vas 1/kart.
Vase 1/box
H: 200 mm/7⁷/₈"

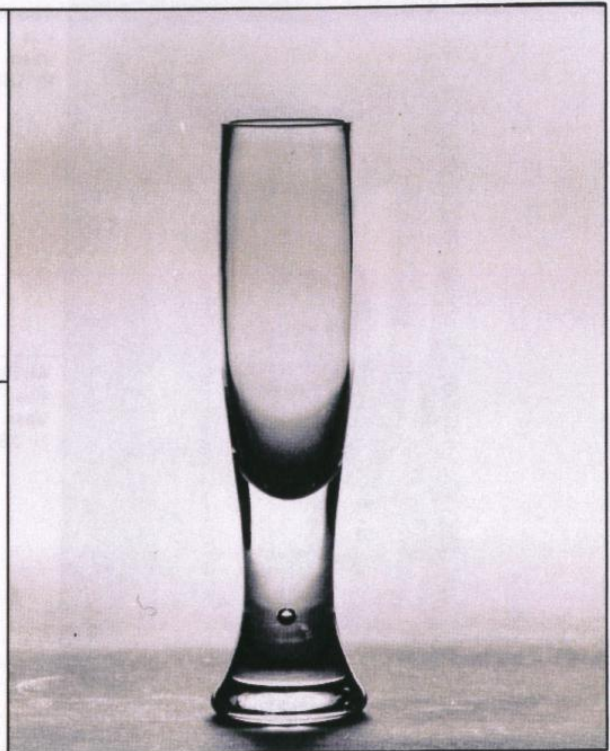

Crystal

Design:
Bengt Edenfalk

Kosta Savoy

44505-5
Vas
Vase
H: 170 mm/6⁵/₈"



44506-5
Vas
Vase
H: 195 mm/7⁵/₈"





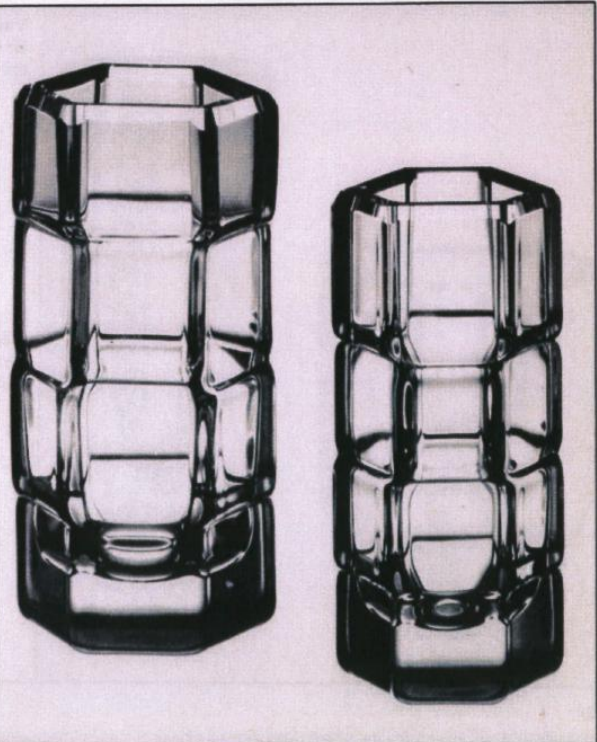

44507-5
Vas
Vase
H: 225 mm/8⁷/₈"





Kosta Utopia

Design:
Göran Wärff

	<p>48018-1 Vas Vase H: 165 mm/6 1/2"</p> 	<p>48019-1 Vas Vase H: 220 mm/8 5/8"</p> 
	<p>48020-1 Vas Vase H: 280 mm/11"</p> 	

Crystal

Design:
Göran Wärff

	<p>48040-1 Vas Vase H: 160 mm/6 1/4" Ø: 155 mm/6 1/8"</p> 	
	<p>48041-1 Vas Vase H: 270 mm/10 5/8" Ø: 110 mm/4 3/8"</p> 	

Crystal

Design:
Bengt Edenfalk

Kosta Stella

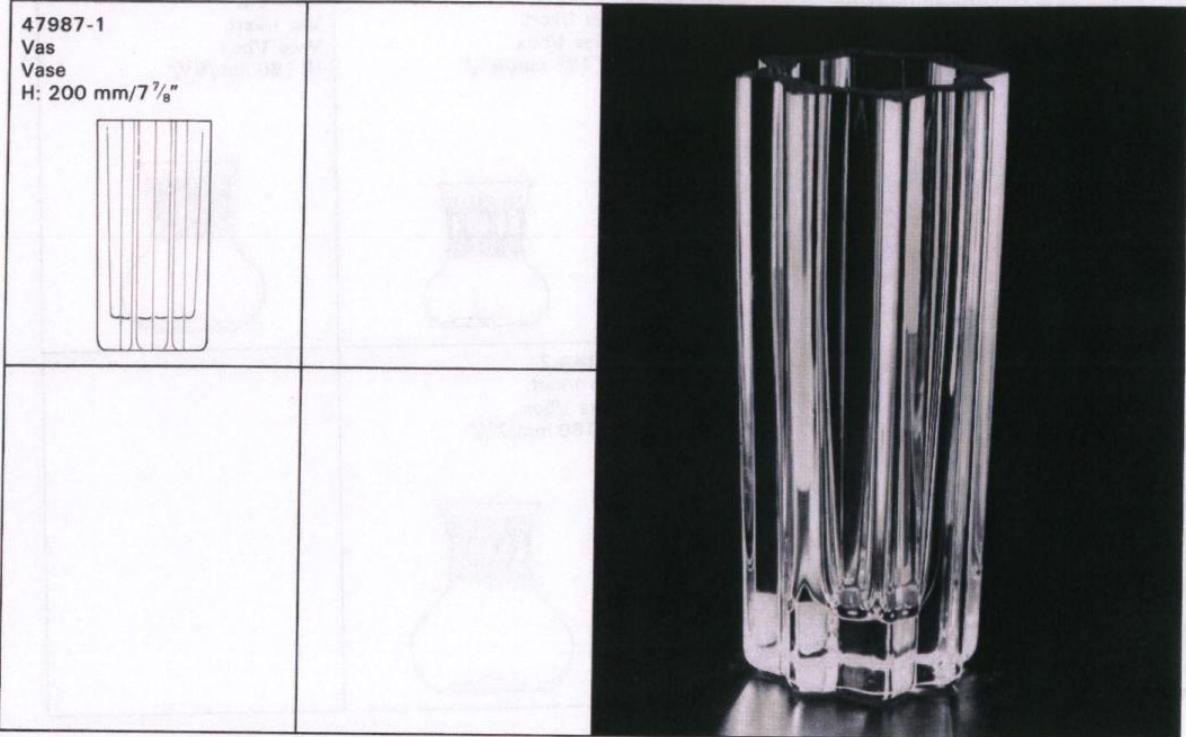

Crystal

Design:
Göran Wärff

Kosta Venus

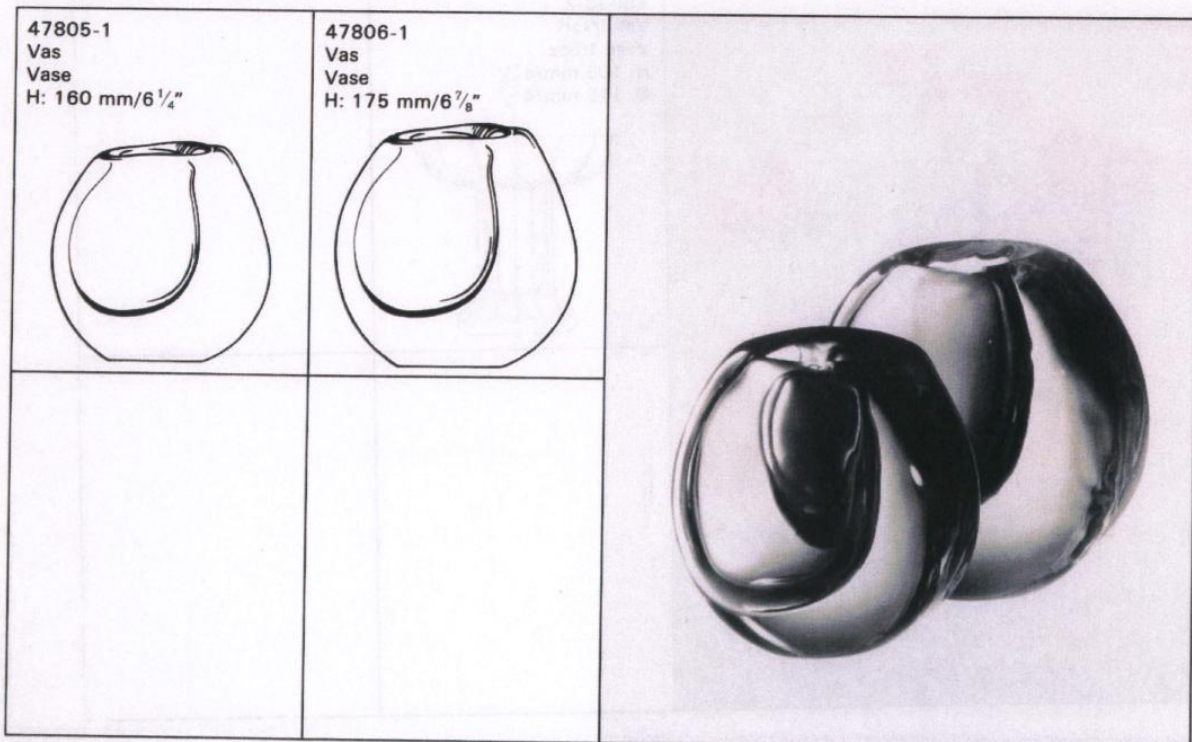

Boda Barock

Design:
Rolf Sinnemark



48142-2
Vas 1/kart.
Vase 1/box
H: 125 mm/4 7/8"

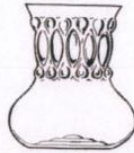

48143-2
Vas 1/kart.
Vase 1/box
H: 160 mm/6 1/4"

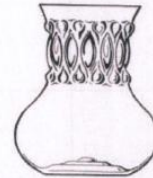

48144-2
Vas 1/kart.
Vase 1/box
H: 180 mm/7 1/8"

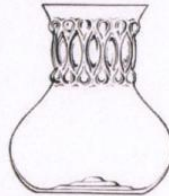

Boda Brudnäbb Boda Brides maid

Design:
Monica Backström



48036-2
Vas 1/kart.
Vase 1/box
H: 105 mm/4 1/8"
Ø: 115 mm/4 1/2"

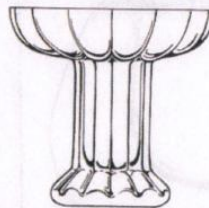





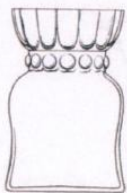

Design:
Rolf Sinnemark

Boda Bukett

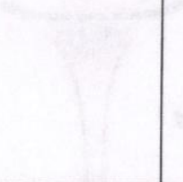

47620-2 lös/loose
47625-2
Vas 1/kart.
Vase 1/box
H: 150 mm/5 7/8"



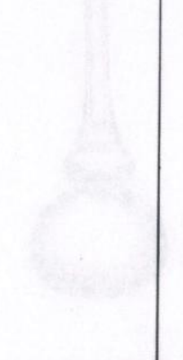
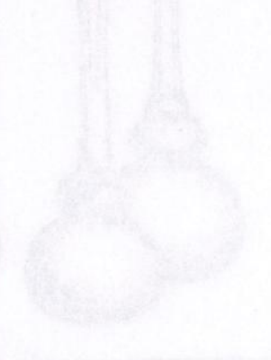

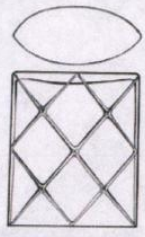
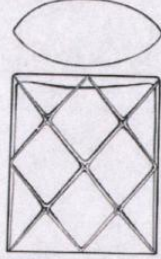

Boda Eliza

Design:
Bertil Vallien

	<p>48053-3 Vas 1/kart. Vase 1/box H: 140 mm/5 1/2"</p> 	
	<p>48054-3 Vas 1/kart. Vase 1/box H: 160 mm/6 1/4"</p> 	

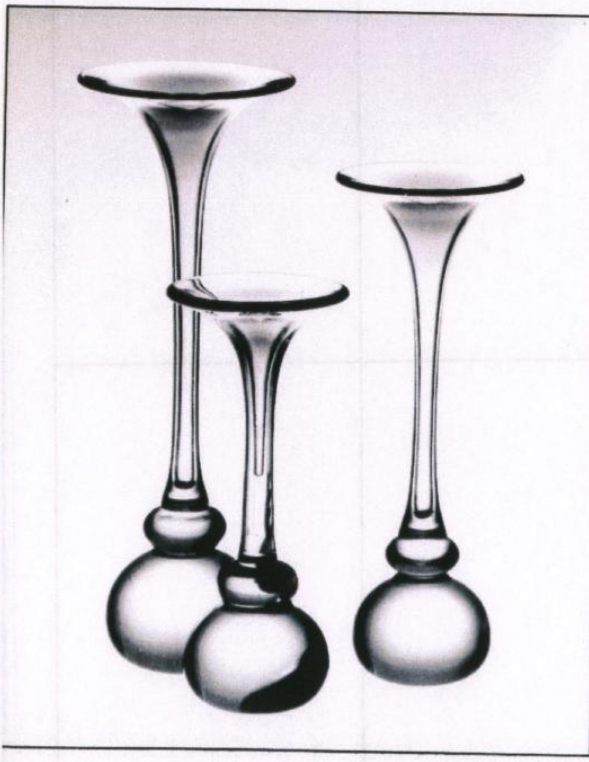
Boda Fontän Boda Fountain

Design:
Rolf Sinnemark

	<p>47841-4 Vas 1/kart. Vase 1/box H: 170 mm/6 5/8"</p> 	<p>47842-4 Vas 1/kart. Vase 1/box H: 215 mm/8 1/4"</p> 
	<p>47843-4 Vas 1/kart. Vase 1/box H: 240 mm/9 1/2"</p> 	

Design:
Monica Backström

Boda Fleur

48157-2
 Vas blå
 Vase blue
 H: 160 mm/6 1/4"



48158-2
 Vas blå
 Vase blue
 H: 220 mm/8 5/8"



48159-2
 Vas blå
 Vase blue
 H: 180 mm/7 1/8"



48160-2
 Vas blå
 Vase blue
 H: 260 mm/10 1/4"



48167-2
 Vas brun
 Vase brown
 H: 160 mm/6 1/4"



48168-2
 Vas brun
 Vase brown
 H: 220 mm/8 5/8"



48169-2
 Vas brun
 Vase brown
 H: 180 mm/7 1/8"



48170-2
 Vas brun
 Vase brown
 H: 260 mm/10 1/4"



48161-2
 Vas rund blå
 Vase round blue
 H: 140 mm/5 1/2"



48162-2
 Vas rund blå
 Vase round blue
 H: 180 mm/7 1/8"



Boda Fleur

Design:
Monica Backström

48171-2
Vas rund rosa
Vase round pink
H: 140 mm/5 1/2"











48172-2
Vas rund rosa
Vase round pink
H: 180 mm/7 1/8"

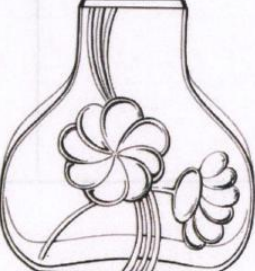

**Design:
Bertil Vallien**

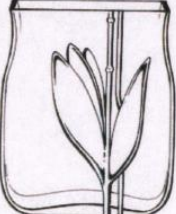
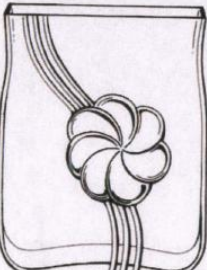
Boda Flower

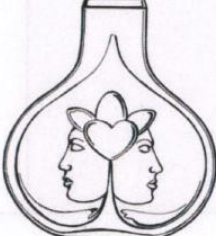
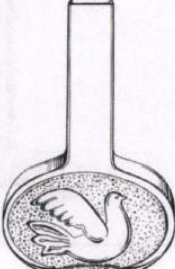
<p>47700-3 Vas "Boda Flower" 1/kart. Vase "Boda Flower" 1/box H: 70 mm/2³/₄"</p> 	<p>47701-3 Vas "Boda Flower" 1/kart. Vase "Boda Flower" 1/box H: 115 mm/4¹/₂"</p> 		
<p>47702-3 Vas "Boda Flower" 1/kart. Vase "Boda Flower" 1/box H: 150 mm/5⁷/₈"</p> 	<p>47703-3 Vas "Boda Flower" 1/kart. Vase "Boda Flower" 1/box H: 190 mm/7¹/₂"</p> 		
<p>47704-3 Vas "Boda Flower" 1/kart. Vase "Boda Flower" 1/box H: 195 mm/7⁵/₈"</p> 	<p>47705-3 Vas "Boda Flower" 1/kart. Vase "Boda Flower" 1/box H: 130 mm/5¹/₈"</p> 	<p>47706-3 Vas "Boda Flower" 1/kart. Vase "Boda Flower" 1/box H: 160 mm/6¹/₄"</p> 	<p>47707-3 Vas "Boda Flower" 1/kart. Vase "Boda Flower" 1/box H: 200 mm/7⁷/₈"</p> 
<p>47708-3 Vas "Boda Flower" 1/kart. Vase "Boda Flower" 1/box H: 210 mm/8¹/₄"</p> 	<p>48133-3 Vas 1/kart. Vase 1/box H: 90 mm/3¹/₂"</p> 	<p>48134-3 Vas 1/kart. Vase 1/box H: 150 mm/5⁷/₈"</p> 	<p>48135-3 Orkidévas 1/kart. Budvase 1/box H: 180 mm/7¹/₈"</p> 

Boda Frezia

Design:
Bertil Vallien

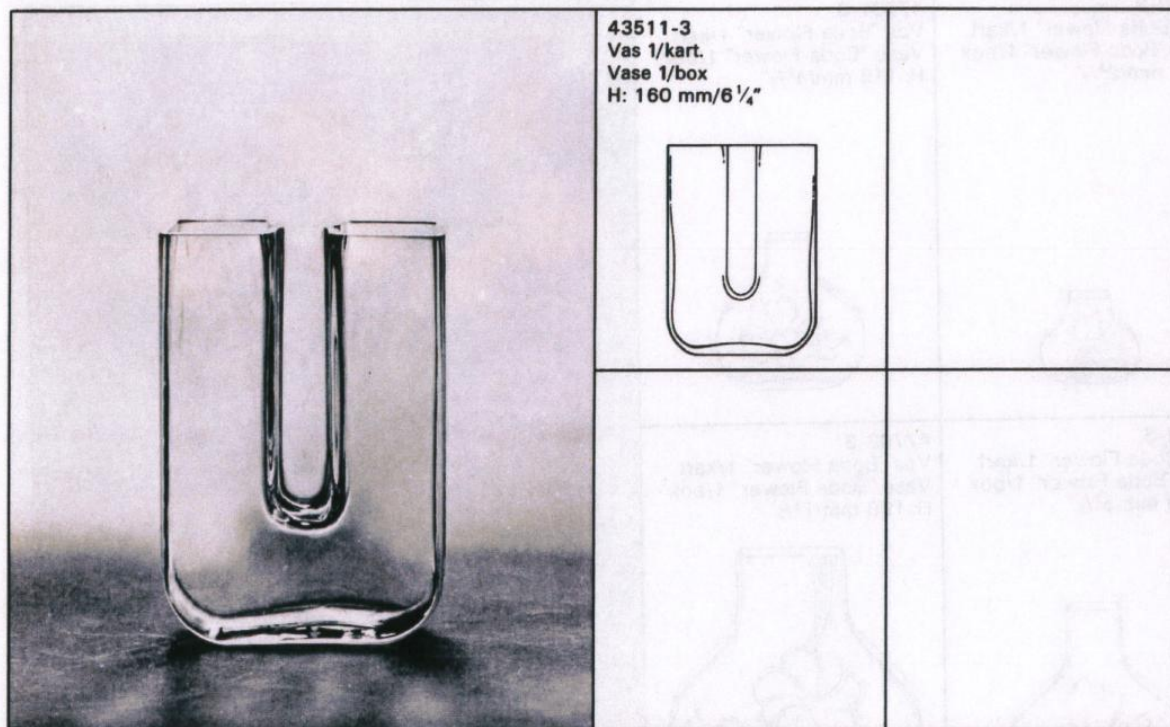

Boda Gracil

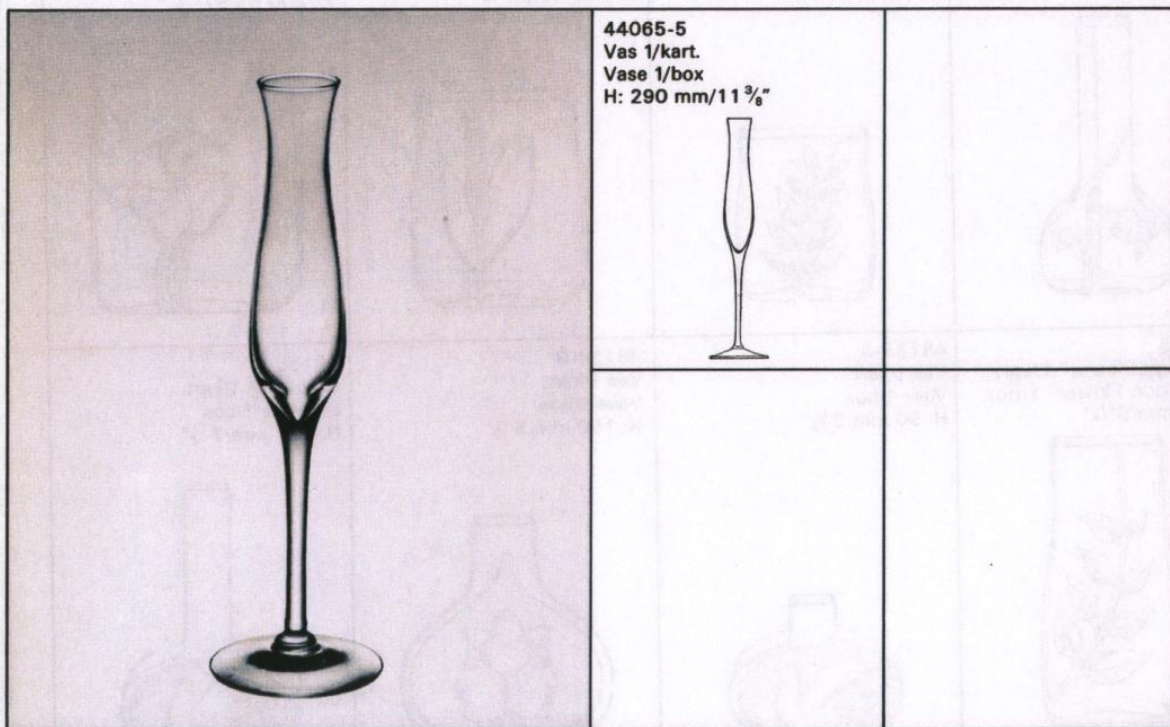

Boda Hjärta Boda Heart

**Design:
Bertil Vallien**

47602-3
Vas 1/kart.
Vase 1/box
H: 200 mm/7⁷/₈"

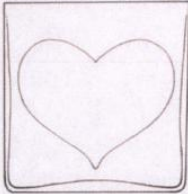

47603-3
Vas 1/kart.
Vase 1/box
H: 230 mm/9"

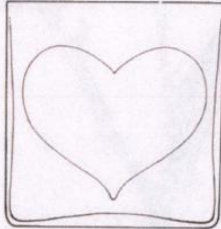

47613-3
Vas mini
1/kart. i 12-pack
Vase mini
1/box in 12/box
H: 85 mm/3³/₈"



47962-3
Vas 1/kart.
Vase 1/box
H: 135 mm/5³/₈"

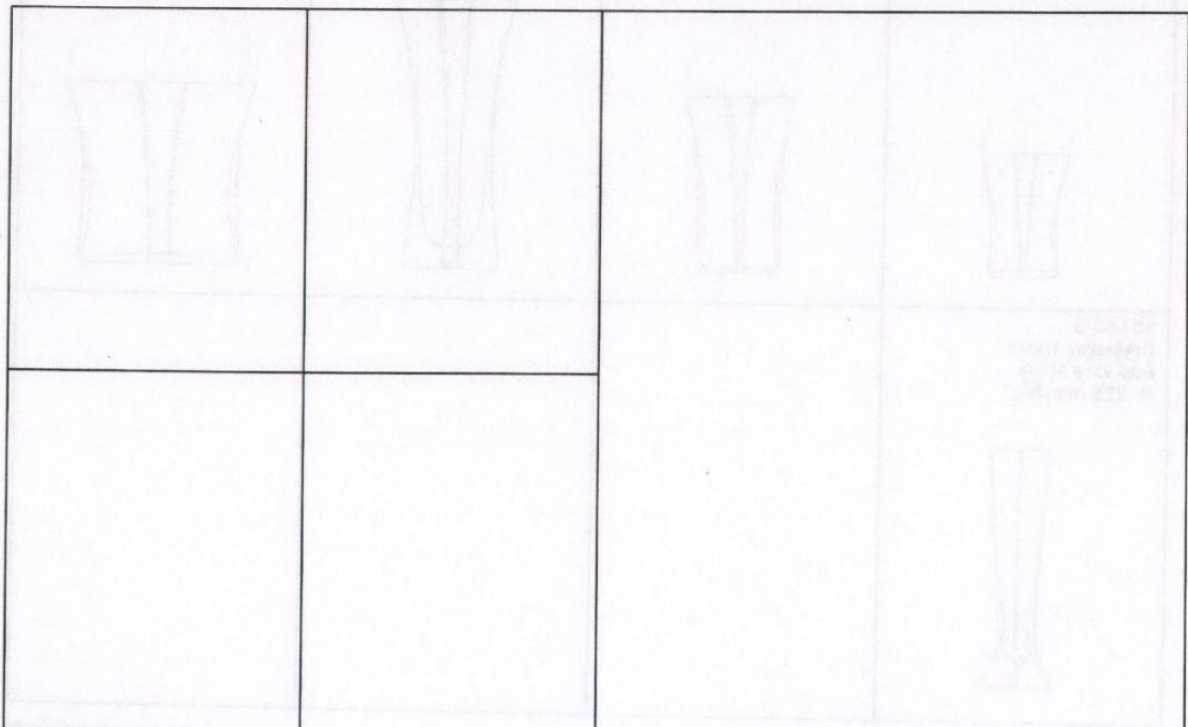
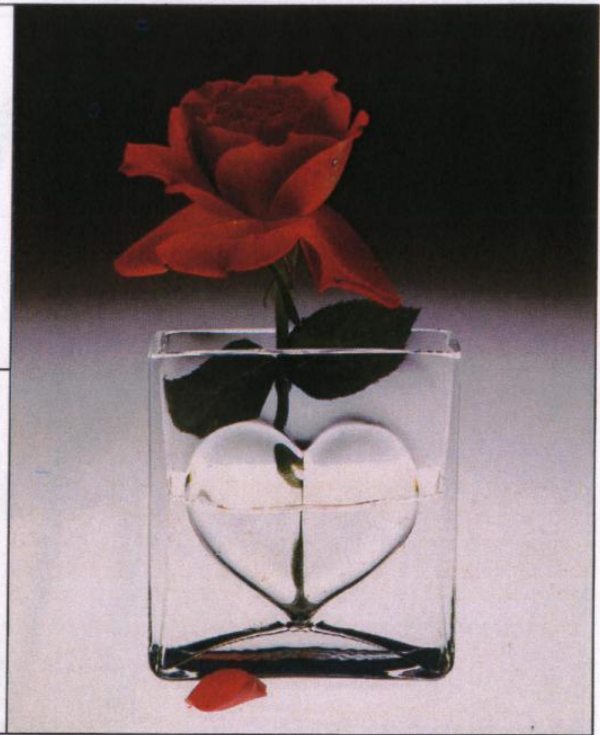

Boda Jenny

Design:
Bertil Vallien



47958-3
Vas 1/kart.
Vase 1/box
H: 90 mm/3 1/2"



47959-3
Vas 1/kart.
Vase 1/box
H: 130 mm/5 1/8"



47960-3
Vas 1/kart.
Vase 1/box
H: 205 mm/8"

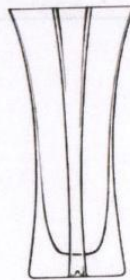

47961-3
Vas vid 1/kart.
Vase wide 1/box
H: 135 mm/5 3/8"

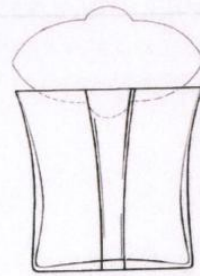



48140-3
Orkidévas 1/kart.
Bud vase 1/box
H: 225 mm/8 7/8"



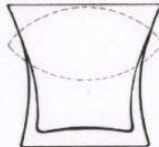

Boda Lily

Design:
Rolf Sinnemark

<p>47810-2 Vas 1/kart. Vase 1/box H: 185 mm/7¹/₄"</p> 	<p>47811-2 Vas 1/kart. Vase 1/box H: 235 mm/9¹/₄"</p> 	
<p>47812-2 Vas 1/kart. Vase 1/box H: 135 mm/5³/₈"</p> 		





Boda Mini

Design:
Signe Persson-Melin

<p>44100-2 Vas "Boda Mini" 16/kart. svensk text 44101-2 Vase "Boda Mini" 16/box English text H: 75 mm/3" Ø: 35 mm/1³/₈"</p> 		





Boda Romance

Design:
Annette Krahnert

	<p>48055-2 Vas 1/kart. Vase 1/box H: 200 mm/7 7/8"</p> 	
		

Boda Rosette

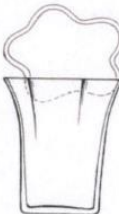
Design:
Bertil Vallien

	<p>47849-3 Vas 1/kart. Vase 1/box H: 100 mm/4"</p> 	<p>47850-3 Vas 1/kart. Vase 1/box H: 140 mm/5 1/2"</p> 
	<p>47851-3 Vas 1/kart. Vase 1/box H: 170 mm/6 5/8"</p> 	<p>47852-3 Vas 1/kart. Vase 1/box H: 200 mm/7 7/8"</p> 

Boda Rustica

Design:
Bertil Vallien



48126-3
Vas 1/kart.
Vase 1/box
H: 115 mm/4 1/2"



48127-3
Vas 1/kart.
Vase 1/box
H: 180 mm/7 1/8"

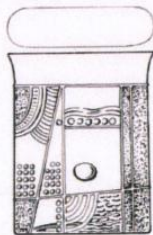

48128-3
Vas 1/kart.
Vase 1/box
H: 200 mm/7 7/8"



48129-3
Vas 1/kart.
Vase 1/box
H: 230 mm/9"

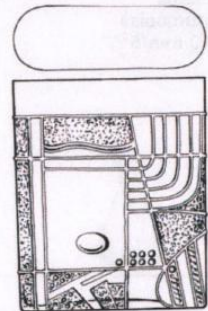

Boda Scarlett

Design:
Monica Backström



48059-2
Vas rosa
Vase pink
H: 190 mm/7 1/2"



48060-2
Vas rosa
Vase pink
H: 235 mm/9 1/4"

48064-2
Vas turkos
Vase turquoise
H: 235 mm/9 1/4"



48061-2
Vas rosa
Vase pink
H: 140 mm/5 1/2"

48065-2
Vas turkos
Vase turquoise
H: 140 mm/5 1/2"



48062-2
Vas rosa
Vase pink
H: 220 mm/8 5/8"

48066-2
Vas turkos
Vase turquoise
H: 220 mm/8 5/8"



Design:
Kjell Engman

Boda Summer



48151-2
Vas bred 1/kart.
Vase wide 1/box
H: 150 mm/5⁷/₈"



48152-2
Vas 1/kart.
Vase 1/box
H: 160 mm/6¹/₄"



48153-2
Vas 1/kart.
Vase 1/box
H: 180 mm/7¹/₈"



48154-2
Vas 1/kart.
Vase 1/box
H: 260 mm/10¹/₄"



Boda Vaser

Design:
Bengt Edenfalk



44483-5
Vas 1/kart.
Vase 1/box
H: 215 mm/8 1/2"



44485-5
Vas 1/kart.
Vase 1/box
H: 285 mm/11 1/4"

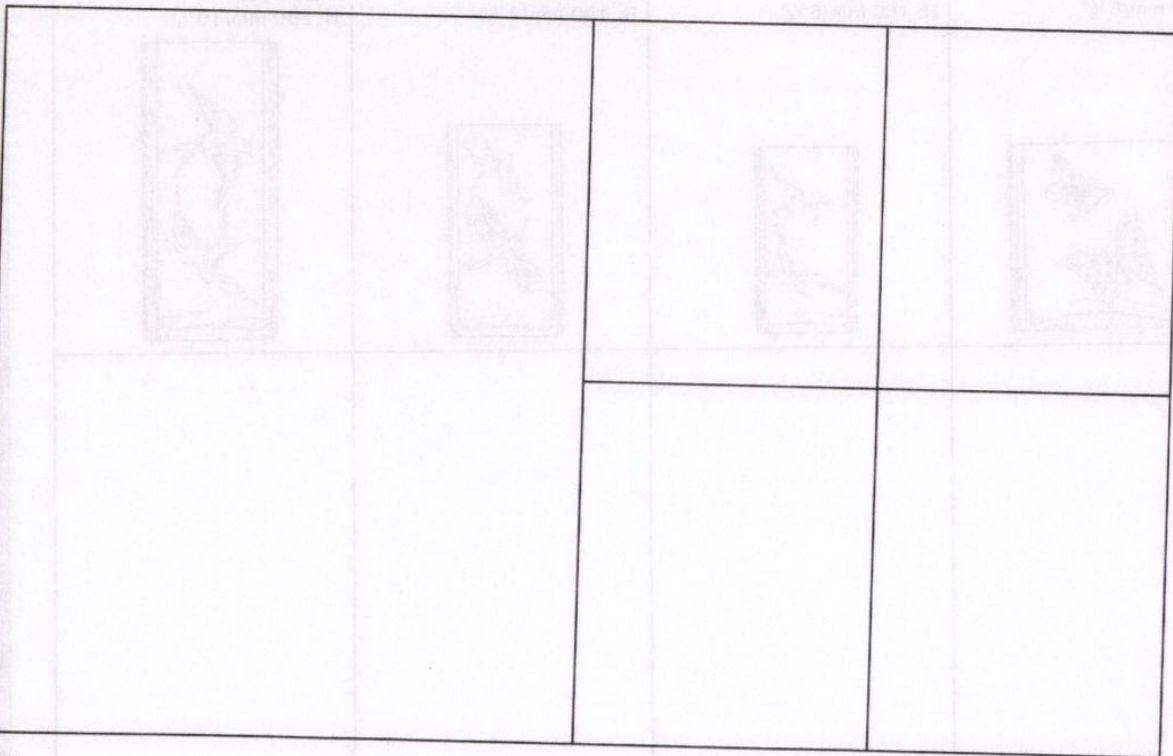

Askfat och skålar
Ashtrays and Bowls



Crystal
Design:
Sigurd Persson
Lisa Bauer

Kosta Blåklocka Kosta Bluebell

57094-1
Skål "Blåklocka" 1/kart.
Bowl "Bluebell" 1/box
H: 150 mm/5⁷/₈"
Ø: 150 mm/5⁷/₈"



57096-1
Skål "Blåklocka" 1/kart.
Bowl "Bluebell" 1/box
H: 120 mm/4³/₄"
Ø: 95 mm/3³/₄"

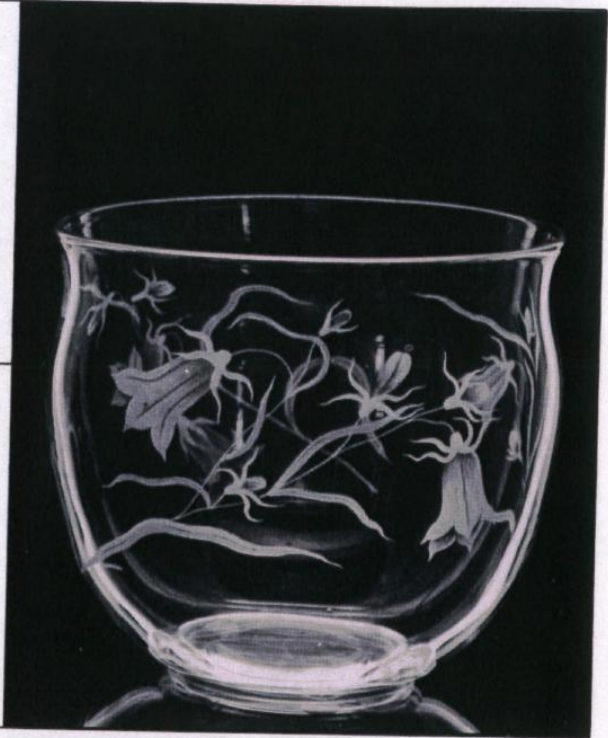

Crystal

Design:
Sigurd Persson

Kosta Fasett

57844-1
Skål
Bowl
H: 95 mm/3³/₄"
Ø: 140 mm/5¹/₂"



Kosta Fjädrar Kosta Feathers

Crystal

Design:
Vicke Lindstrand



52451-1
Skål "Fjädrar" på fot
Bowl "Feathers" on foot
H: 210 mm/8 1/4"
Ø: 205 mm/8"



Crystal

Kosta King

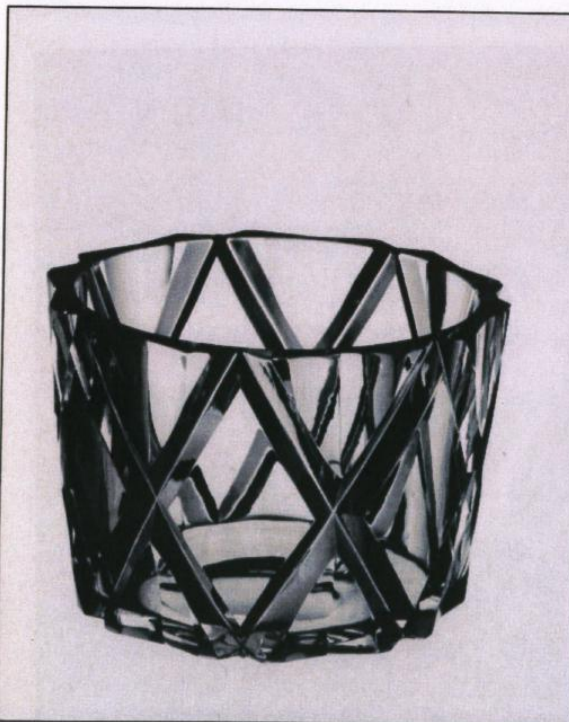

57504-1
Skål 1/kart.
Bowl 1/box
Ø: 180 mm/7 1/8"

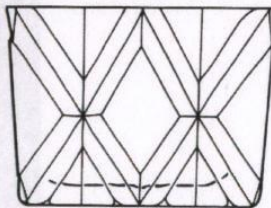

Crystal
Design:
Sigurd Persson
Lisa Bauer

Kosta Krokus Kosta Crocus

57481-1
Skål "Krokus"
Bowl "Crocus"
H: 105 mm/4¹/₈"
Ø: 205 mm/8"

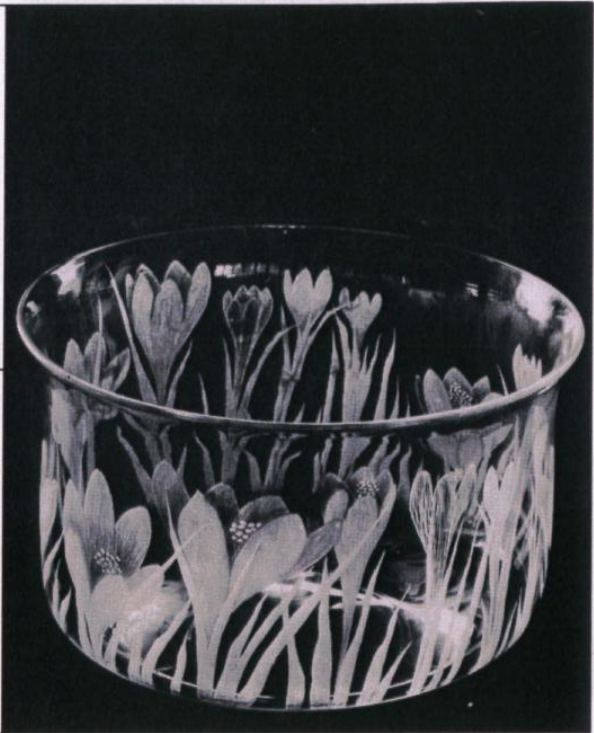

Kosta Rose

57602-1
Skål
Bowl
H: 85 mm/3³/₈"
Ø: 165 mm/6¹/₂"

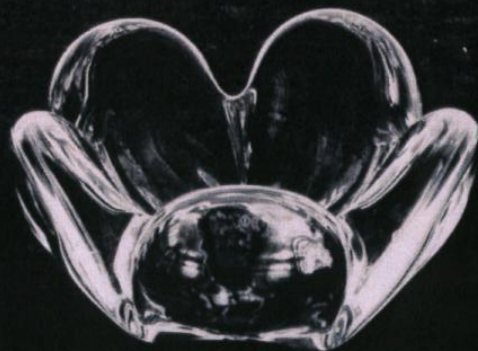

Kosta Skål Groda
Kosta Bowl Frog

Crystal

Design:
Mats Jonasson

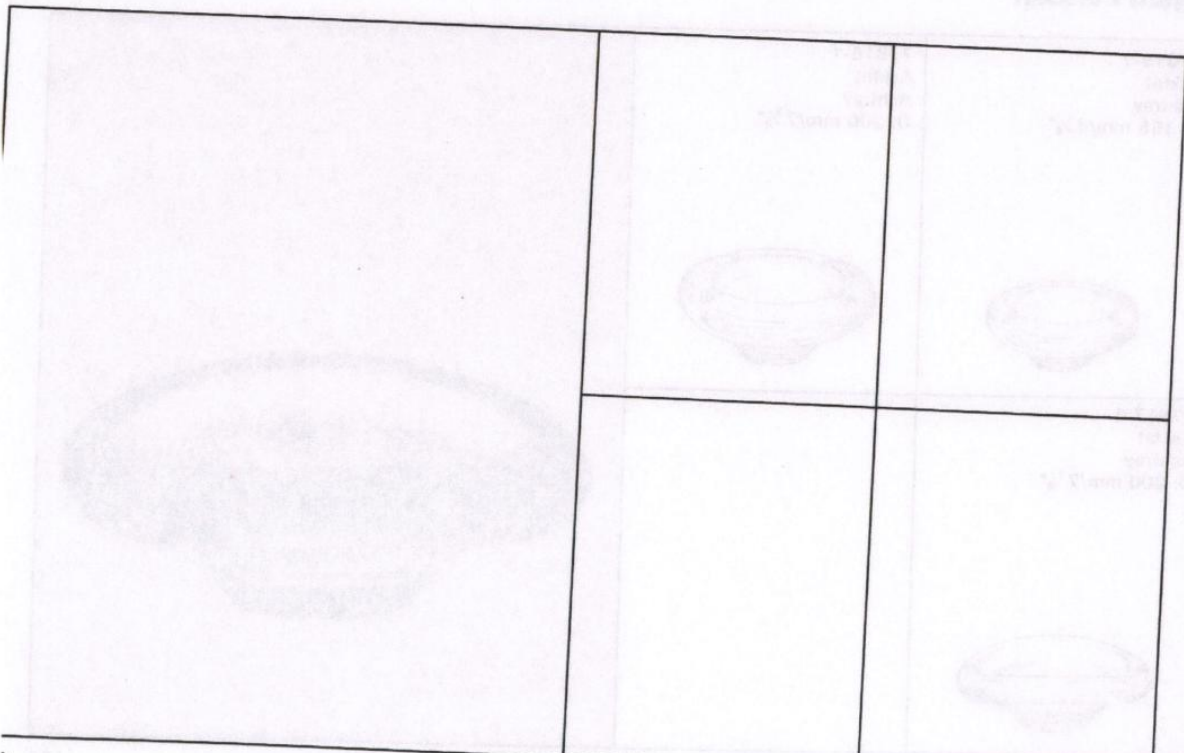
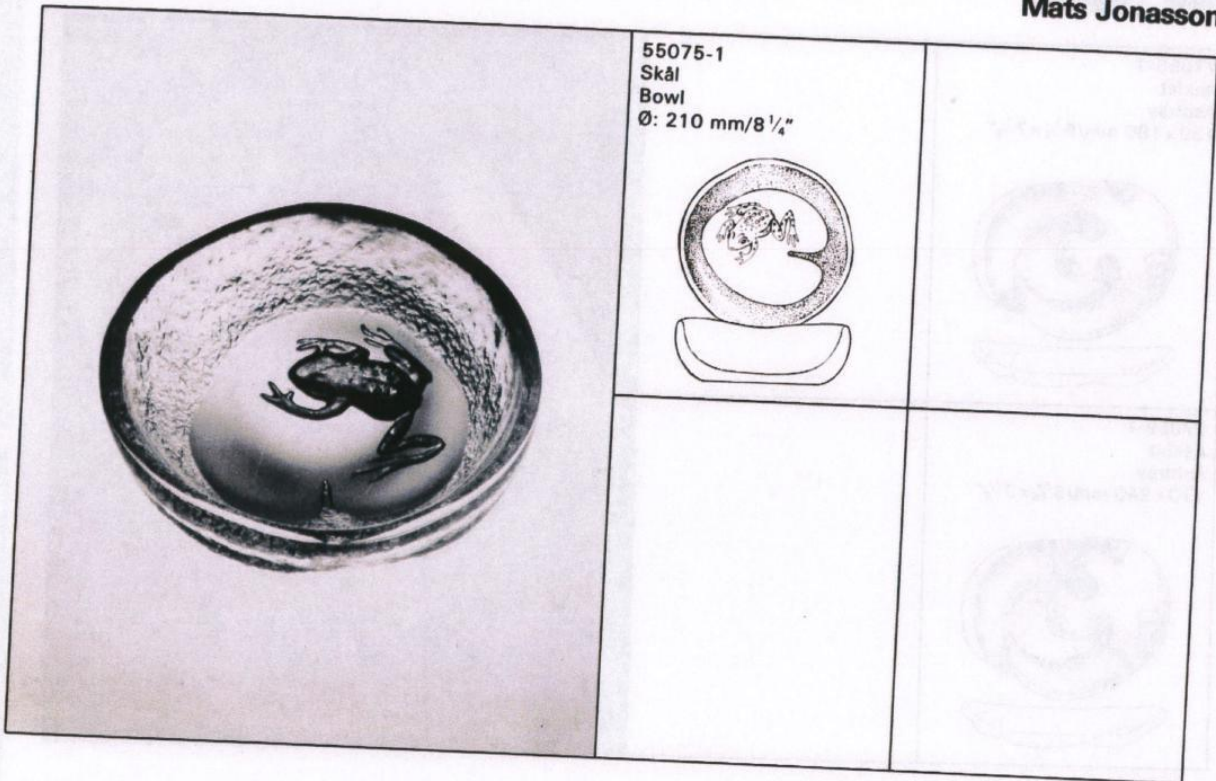

Crystal

Design:
Mats Jonasson

Kosta Askfat Panda Kosta Ashtray Panda

77058-1
Askfat
Ashtray
130 x 180 mm / 5 1/8 x 7 1/8"

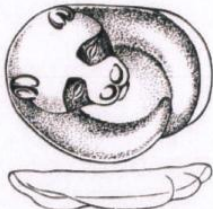

77059-1
Askfat
Ashtray
170 x 240 mm / 6 5/8 x 9 1/2"



Crystal

Design:
Sigurd Persson

Kosta Askfat

77815-1
Askfat
Ashtray
Ø: 155 mm / 6 1/8"



77816-1
Askfat
Ashtray
Ø: 200 mm / 7 7/8"



77817-1
Askfat
Ashtray
Ø: 200 mm / 7 7/8"



Boda HC Andersen

Design:
Kjell Engman

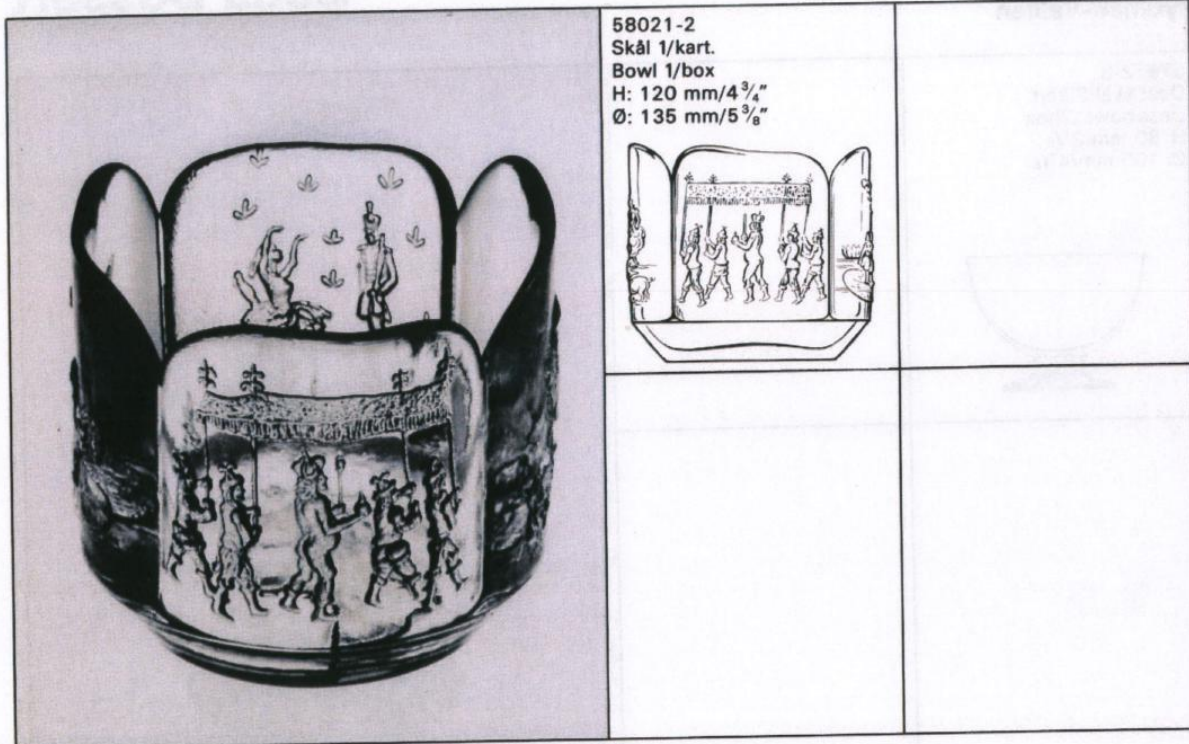

Boda Nils Holgersson

Design:
Kjell Engman

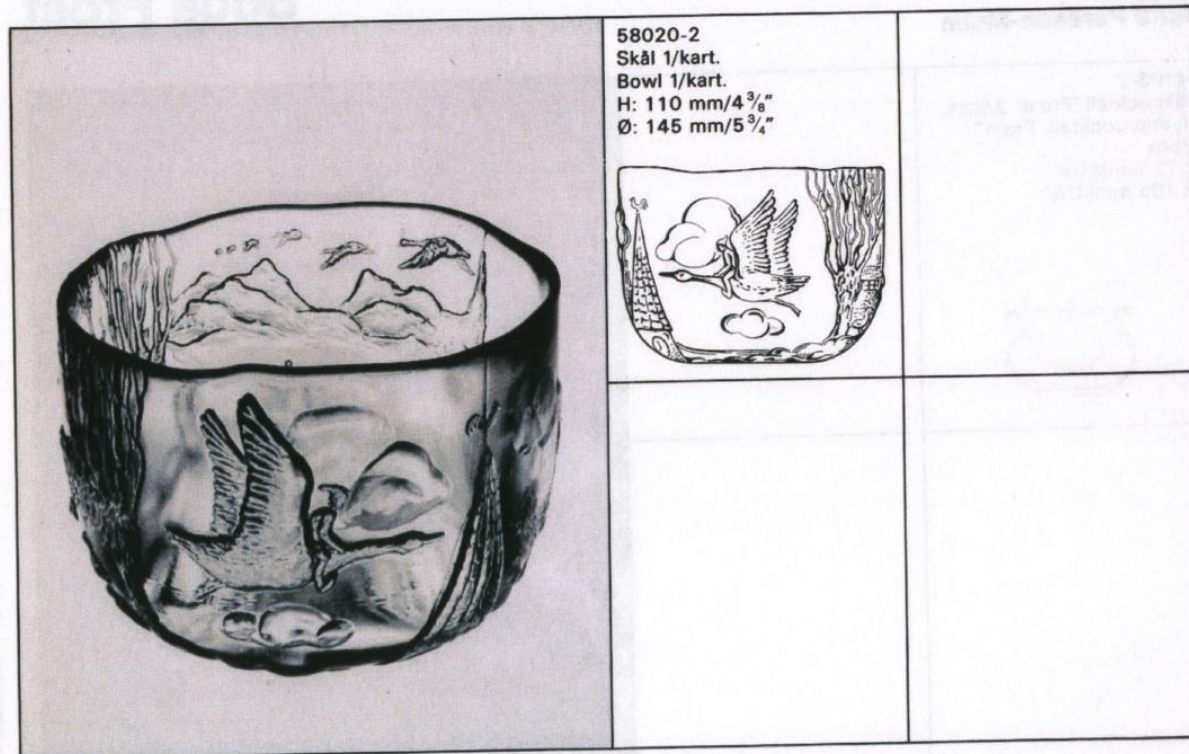

Design:
Ulrica
Hydman-Vallien

Boda Dessert

57972-3
Dess.skål 2/kart.
Dess.bowl 2/box
H: 80 mm/3¹/₈"
Ø: 105 mm/4¹/₈"

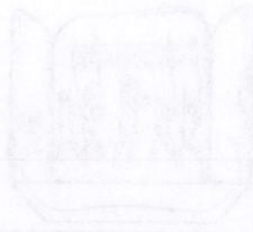

Design:
Signe Persson-Melin

Boda Frost

94103-2
Räkcocktail "Frost" 2/kart.
Shrimp cocktail "Frost"
2/box
H: 73 mm/2⁷/₈"
Ø: 105 mm/4¹/₈"



Boda Sallad

Design:
Bertil Vallien

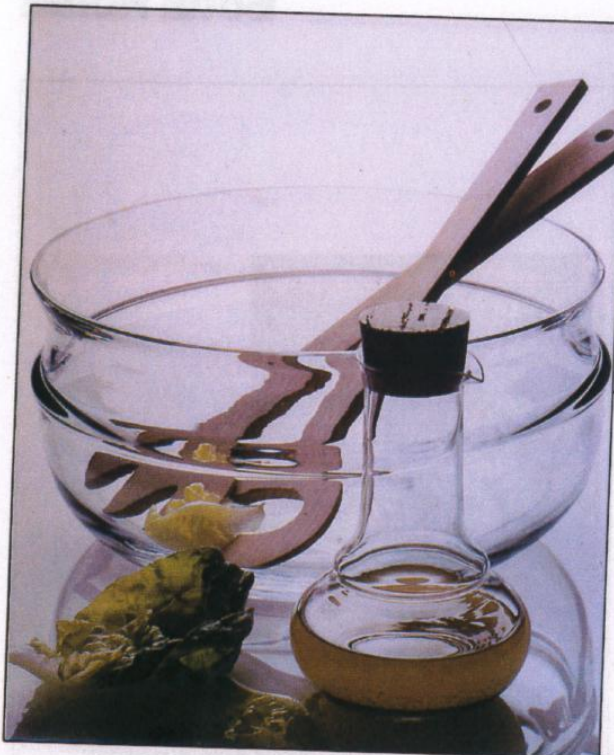

57536-3
Skål
Bowl
Ø: 200 mm/7 7/8"

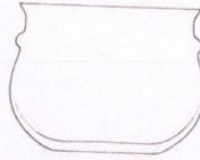

57662-3
Skål 1/kart.
Bowl 1/box
Ø: 240 mm/9 1/2"

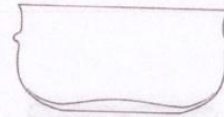

97663-2
Salladsbestick
Salad servers
L: 295 mm/11 5/8"

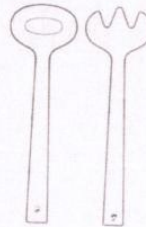

Boda Tintomara

Design:
Bertil Vallien

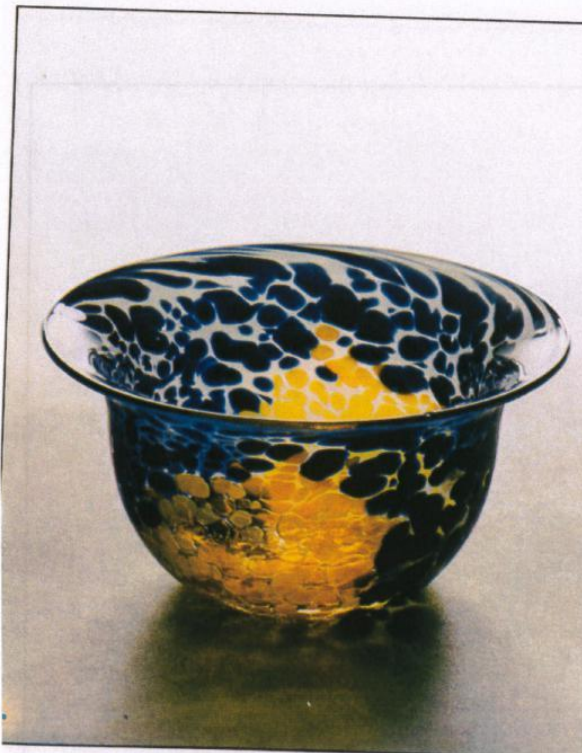

51712-3
Skål "Sverige" blågul 1/kart.
Bowl "Sweden" blue-yellow
1/box
H: 50 mm/2"
Ø: 100 mm/4"



51722-3
Skål "Sverige" blågul 1/kart.
Bowl "Sweden" blue-yellow
1/box
H: 70 mm/2 3/4"
Ø: 135 mm/5 3/8"



Boda Roma

Design:
Rolf Sinnemark

77544-2
Askfat 1/kart.
Ashtray 1/box
Ø: 130 mm/5 1/8"



77545-2
Askfat 1/kart.
Ashtray 1/box
Ø: 170 mm/6 5/8"

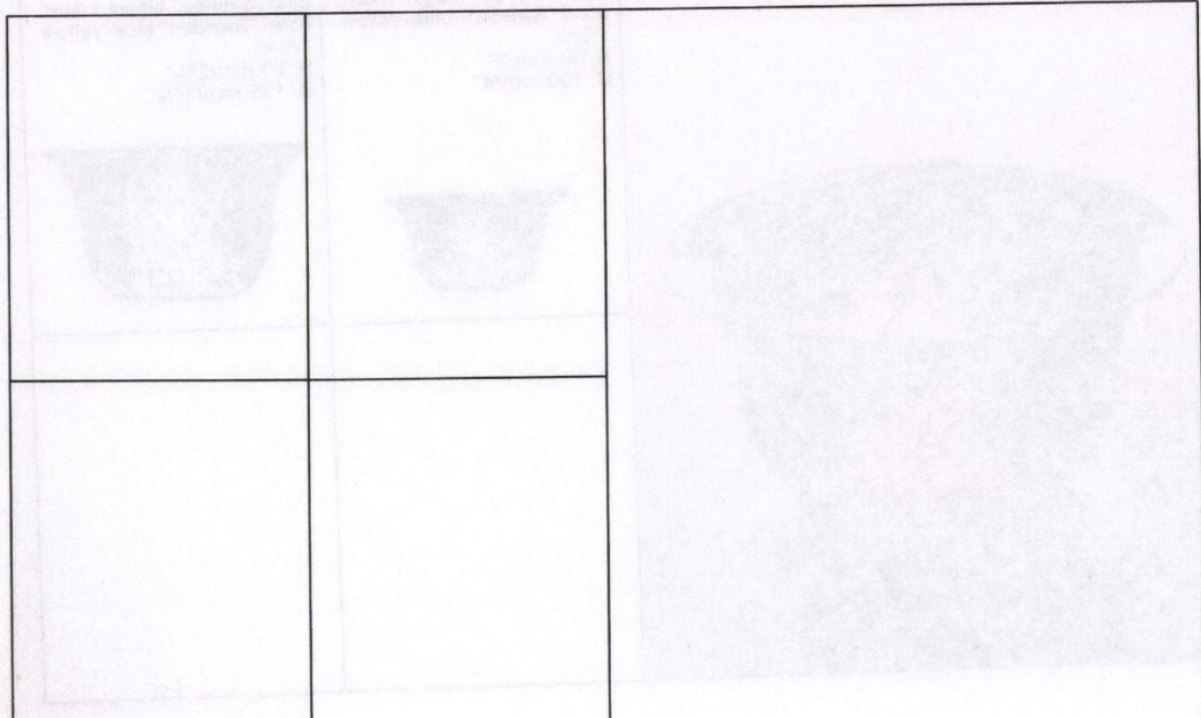

**Ljusstakar
Candlesticks**



Crystal

Kosta One

Design:
Göran Wärff

68101-1
Ljusstake
Candlestick
H: 160 mm/6 1/4"



68102-1
Ljusstake
Candlestick
H: 200 mm/7 7/8"

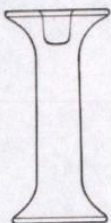

68103-1
Ljusstake
Candlestick
H: 230 mm/9"

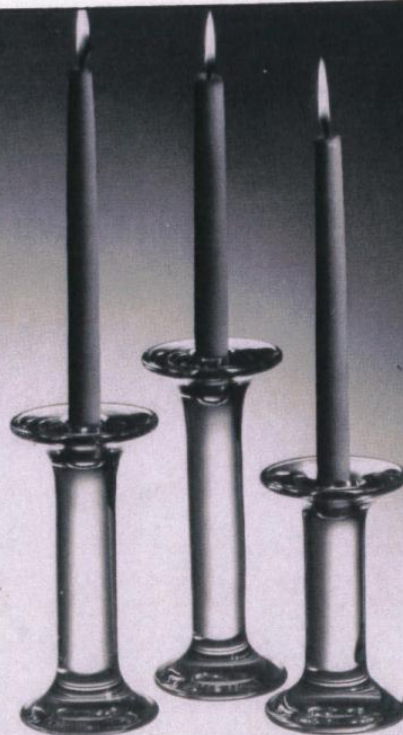
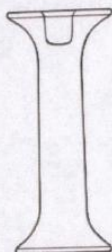

Kosta Ljushuvud Kosta Bright Head

Design:
Bertil Vallien

68108-1
Ljuslykta Ljushuvud 1/kart.
Candleholder girl 1/box
H: 90 mm/3 1/2"





68109-1
Ljuslykta Ljushuvud 1/kart.
Candleholder boy 1/box
H: 90 mm/3 1/2"



Kosta Ellipse

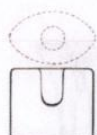



Design:
Göran Wärff

	<p>68004-1 Ljusstake Candlestick H: 90 mm/3 1/2" Ø: 110 x 75 mm/4 3/8 x 3"</p> 	<p>68005-1 Ljusstake Candlestick H: 150 mm/5 7/8" Ø: 110 x 75 mm/4 3/8 x 3"</p> 
	<p>68006-1 Ljusstake Candlestick H: 185 mm/7 1/4" Ø: 110 x 75 mm/4 3/8 x 3"</p> 	

Kosta Spiral

Crystal

Design:
Göran Wärff

	<p>68012-1 Ljusstake Candlestick H: 95 mm/3 3/4"</p> 	<p>68013-1 Ljusstake Candlestick H: 140 mm/5 1/2"</p> 
	<p>68014-1 Ljusstake Candlestick H: 190 mm/7 1/2"</p> 	

Crystal

**Design:
Göran Wärff**

Kosta Igloo

67406-1
Ljusstake "Igloo" 1/kart.
Candlestick "Igloo" 1/box
H: 95 mm/3³/₄"



67407-1
Ljusstake "Igloo" 1/kart.
Candlestick "Igloo" 1/box
H: 65 mm/2¹/₂"



Crystal

**Design:
Göran Wärff**

Kosta Polar

67513-1
Ljusstake "Polar" 1/kart.
Candlestick "Polar" 1/box
H: 130 mm/5¹/₈"



67514-1
Ljusstake "Polar" 1/kart.
Candlestick "Polar" 1/box
H: 180 mm/7¹/₈"



67714-1
Ljuslykta "Polar" 1/kart.
Hurricane lamp "Polar" 1/box
H: 80 mm/3¹/₈"



67715-1
Ljusstake "Polar" 1/kart.
Candlestick "Polar" 1/box
H: 60 mm/2³/₈"



Kosta Rosenknopp

Kosta Rosebud

Crystal

Design:
Mats Jonasson

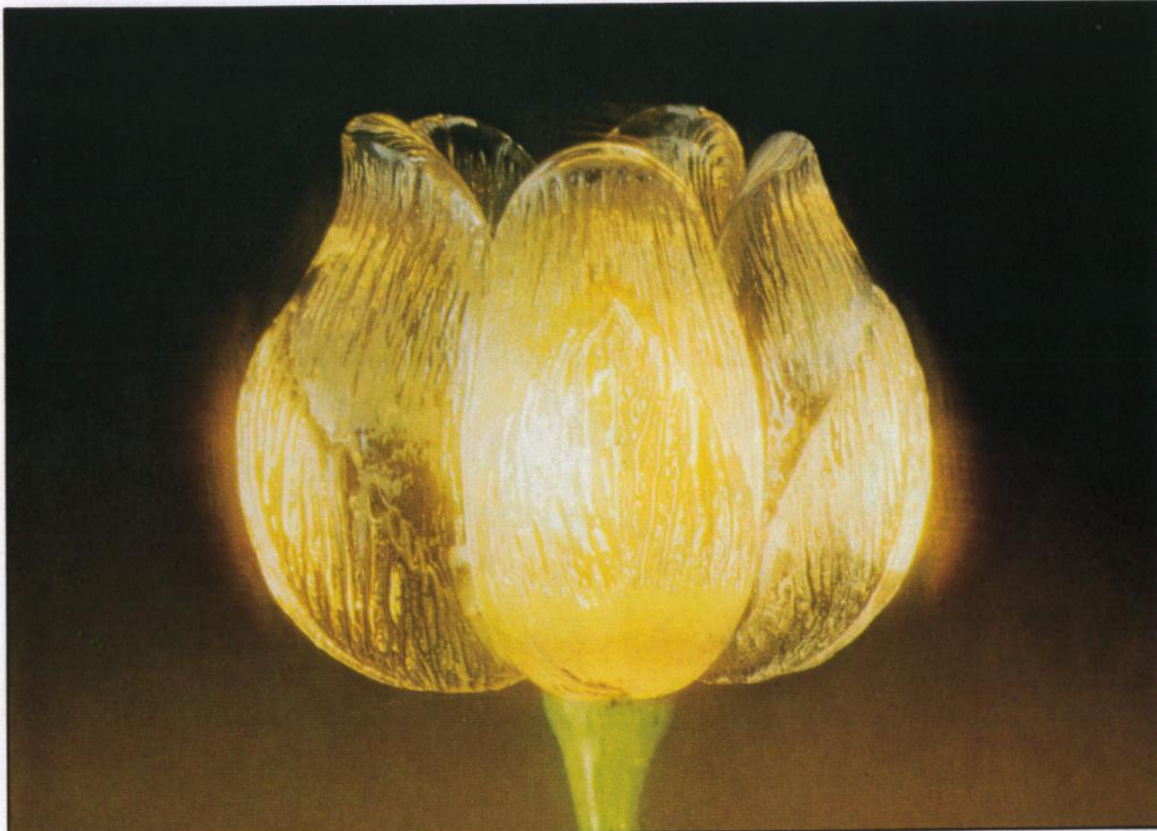

67975-1
Ljuslykta 1/kart.
Hurricane lamp 1/box
H: 65 mm/2 1/2"



68007-1
Ljusstake 1/kart.
Candlelight 1/box
H: 50 mm/2"



68008-1
Ljusstake på fot 1/kart.
Candlestick footed 1/box
H: 110 mm/4 3/8"



68009-1
Ljuslykta på fot 1/kart.
Hurricane lamp footed 1/box
H: 145 mm/5 3/4"



Crystal

Design:
Ann Wärff

Kosta Snöboll Kosta Snowball



67349-1
Ljusstake 1/kart.
Candlestick 1/box
H: 60 mm/2³/₈"



67350-1
Ljuslykta 1/kart.
Hurricane lamp 1/box
H: 70 mm/2³/₄"



67353-1
Ljuslykta 1/kart.
Hurricane lamp 1/box
H: 90 mm/3¹/₂"

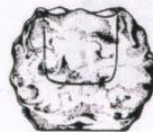

67351-1
Ljuslykta 1/röd kart.
Hurricane lamp 1/red box
H: 70 mm/2³/₄"



97549-1
Tändare 1/kart.
Lighter 1/box
H: 80 mm/3¹/₈"



67800-1
Ljuslykta 1/kart.
Hurricane lamp 1/box
H: 60 mm/2³/₈"



Boda Ann

Design:
Arne Branzell

67803-4
Ljusstake 1/kart.
Candlestick 1/box
H: 170 mm/6⁵/₈"



67804-4
Ljusstake 1/kart.
Candlestick 1/box
H: 245 mm/9⁵/₈"



67805-4
Ljusstake 1/kart.
Candlestick 1/box
H: 270 mm/10⁵/₈"



Design:
Bertil Vallien

67511-3
Ljusstake med handtag
1/kart.
Candlestick with handle
1/box
Ø: 110 mm/4³/₈"

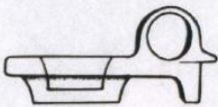

67634-3
Ljusstake med handtag
1/kart.
Candlestick with handle
1/box
Ø: 150 mm/5⁷/₈"

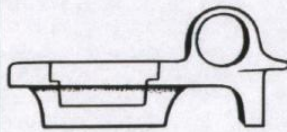

Boda Bellis

Design:
Kjell Blomberg

66044-5
Ljuskrans Bellis 1/kart.
Candle-ring Bellis 1/box
Ø: 155 mm/5 7/8"



66045-5
Ljuskrans 1/kart.
Candle-ring 1/box
Ø: 250 mm/9 7/8"



Boda Adventstjärna Boda Christmas Star

Design:
Kjell Blomberg

66250-5
Adventstjärna 1/kart.
Christmas Star 1/box
Ø: 230 mm/9"

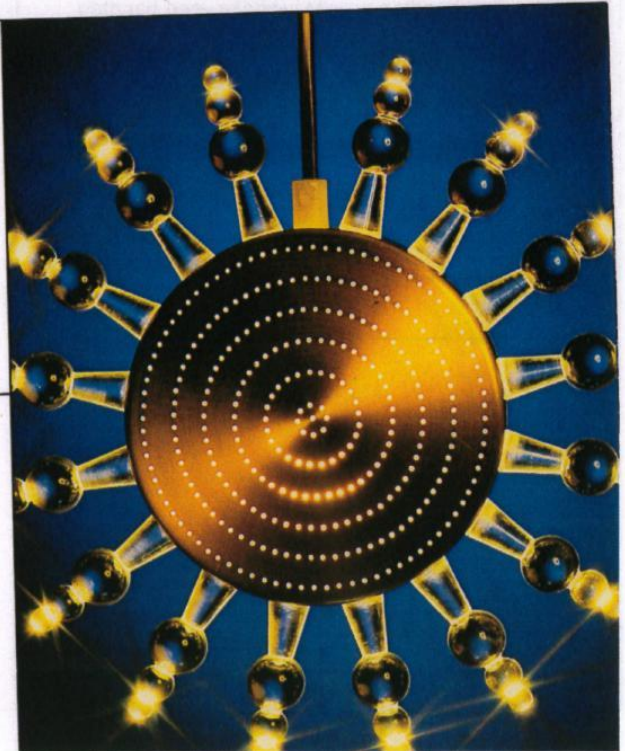
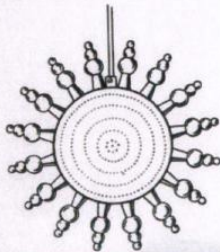

Design:
Bertil Vallien

61511-3
Ljusstake 3-armed 1/kart.
Candlestick 3 branches
1/box
H: 260 mm/10¹/₄"

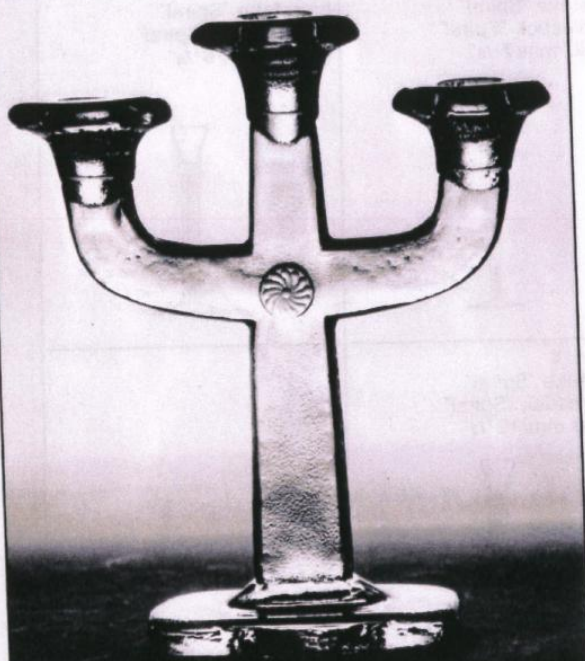

Boda Mini





Design:
Signe Persson-Melin

67589-2
Ljuslykta "Mini" 18/kart.
Hurricane lamp "Mini" 18/box
H: 70 mm/2³/₄"



Design:
Rolf Sinnemark

Boda Spiral

<p>60023-4 Ljusstake "Spiral" Candlestick "Spiral" H: 180 mm/7¹/₈"</p> 	<p>60024-4 Ljusstake "Spiral" Candlestick "Spiral" H: 250 mm/9⁷/₈"</p> 	
<p>60025-4 Ljusstake "Spiral" Candlestick "Spiral" H: 320 mm/12¹/₂"</p> 		



Karaffer och kannor
Decanters and Jugs



Crystal

**Design:
Göran Wärff**

Kosta Up and Down

<p>88101-1 Karaff 50 cl Decanter 18 oz H: 240 mm/9 1/2"</p> 	<p>88102-1 Karaff 75 cl Decanter 26 oz H: 280 mm/11"</p> 	

Crystal

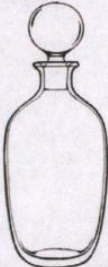
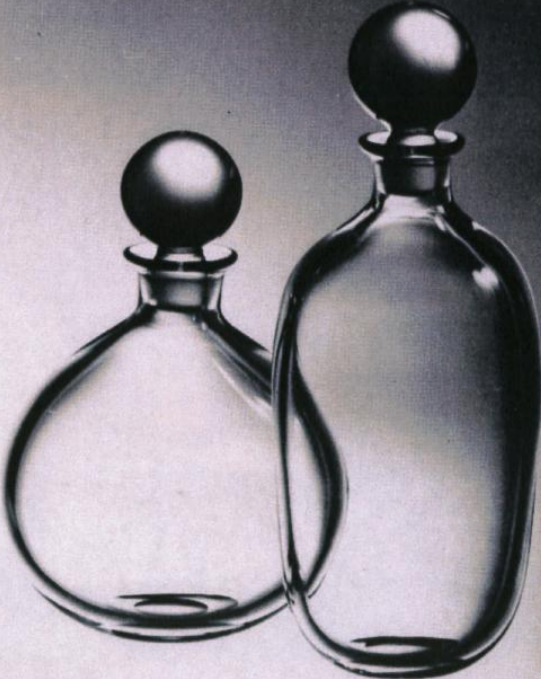
<p>88103-1 Karaff 100 cl Decanter 35 oz H: 250 mm/9 7/8"</p> 	<p>88104-1 Karaff 100 cl Decanter 35 oz H: 330 mm/13"</p> 	

Boda Chill a liter

Design:
Bo Borgström

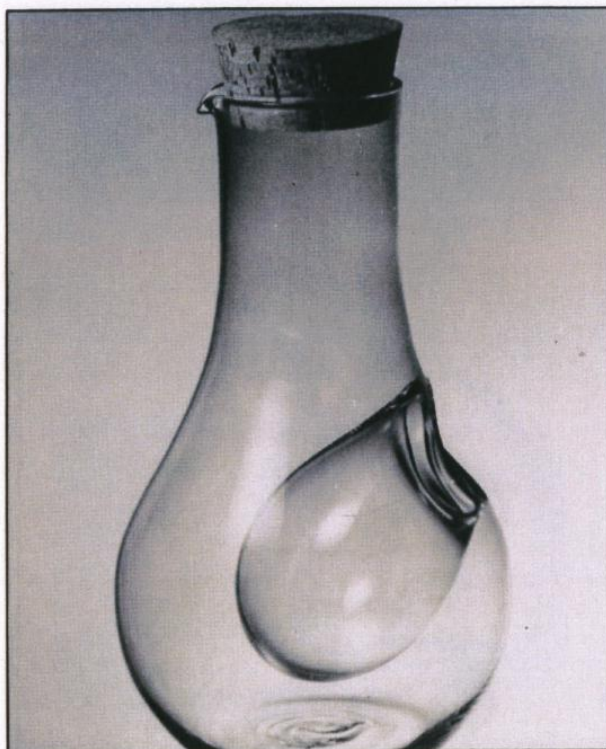

82857-5
Karaff 95 cl 1/kart.
Decanter 33 2/5 oz 1/box
H: 230 mm/9"



Boda Droppe Boda Winedrop

Design:
Rolf Sinnemark

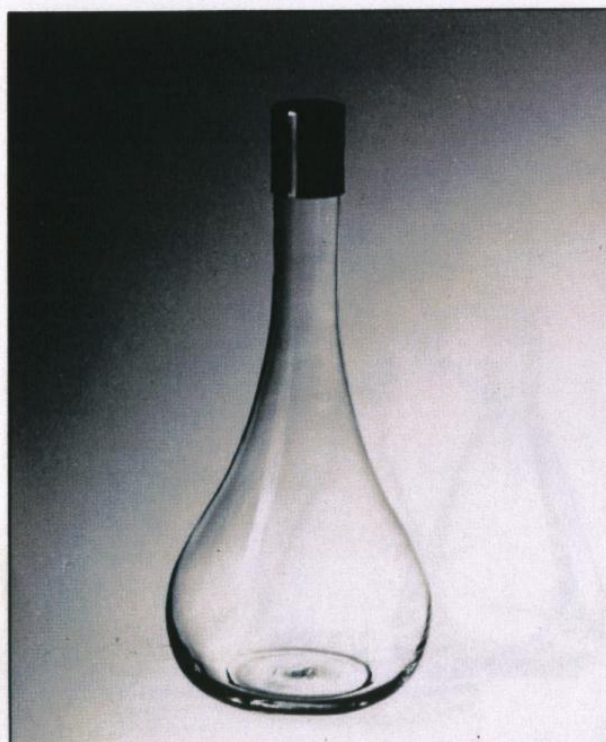





88106-2
Karaff 75 cl 1/kart.
Decanter 26 2/5 oz 1/box
H: 285 mm/11 1/4"







Boda Fjord

Design:
Bo Borgström

<p>88062-5 Karaff Decanter H: 320 mm/12 1/2"</p> 		
<p>88063-5 Karaff Decanter H: 255 mm/10"</p> 		

Boda Metric

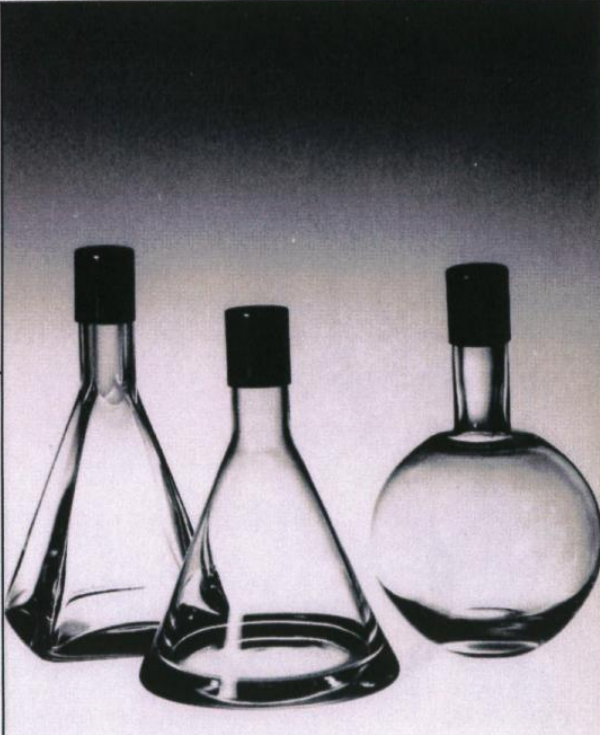
Design:
Rolf Sinnemark

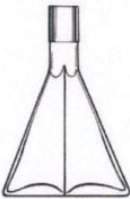
<p>88118-2 Karaff 75 cl Klot 1/kart. Decanter 26 2/5 oz Globe 1/box H: 215 mm/8 1/2"</p> 	<p>88119-2 Karaff 75 cl Kon 1/kart. Decanter 26 2/5 oz Cone 1/box H: 205 mm/8"</p> 	
<p>88120-2 Karaff 75 cl Kub 1/kart. Decanter 26 2/5 oz Cube 1/box H: 225 mm/8 7/8"</p> 	<p>88121-2 Karaff 75 cl Pyramid 1/kart. Decanter 26 2/5 oz Pyramide 1/box H: 225 mm/8 7/8"</p> 	

Boda Higgins

Design:
Bertil Vallien



88112-3
Karaff 50 cl 1/kart.
Decanter 17³/₅ oz 1/box
H: 220 mm/8⁵/₈"



88113-3
Karaff 75 cl 1/kart.
Decanter 26 oz 1/box
H: 255 mm/10"



Boda Optic

Design:
Ulrica Hydman-Vallien

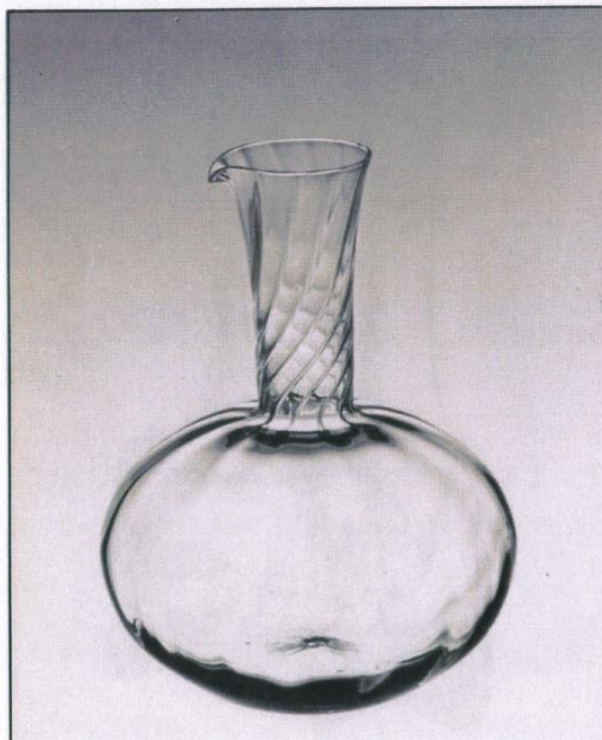

88108-3
Karaff 100 cl
Decanter 35 oz





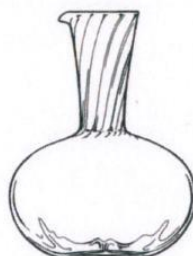

88109-3
Karaff 175 cl
Decanter 60 oz







Boda Skeppskaraff Boda Ships Decanter



Design:
Rolf Sinnemark

<p>87543-2 Skeppskaraff 140 cl 1/kart. Ship-decanter 49³/₁₀ oz 1/box H: 300 mm/11³/₄"</p> 		
<p>87544-2 Skeppskaraff 100 cl 1/kart. Ship-decanter 35¹/₁₀ oz 1/box H: 245 mm/9⁵/₈"</p> 		

Design:
Bo Borgström



Boda Skol

<p>82835-5 Karaff Decanter H: 280 mm/11"</p> 		
<p>82837-5 Karaff Decanter H: 250 mm/9⁷/₈"</p> 		

	<p>87807-2 Skeppskaraff 85 cl Ships decanter 29⁹/₁₀ oz H: 215 mm/8¹/₂"</p>	<p>87808-2 Skeppskaraff 135 cl Ships decanter 47¹/₂ oz H: 230 mm/9"</p>
		

Boda Tradition

Design:
Rolf Sinnemark

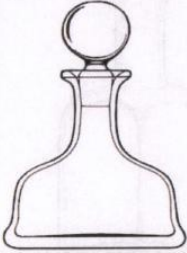
	<p>88018-2 Karaff 75 cl Decanter 26²/₆ oz H: 225 mm/8⁷/₈"</p>	<p>88019-2 Karaff 100 cl Decanter 35 oz H: 250 mm/9⁷/₈"</p>
		

Boda Karaffer Boda Decanter

Design:
Annette Krahnert

88001-2
Karaff rund
Decanter round
H: 180 mm/7 1/8"

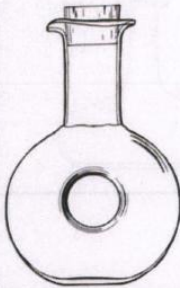

88002-2
Karaff fyrkantig
Decanter square
H: 180 mm/7 1/8"



88003-2
Karaff romb
Decanter rhomb
H: 180 mm/7 1/8"



88059-2
Karaff rund 75 cl 1/kart.
Decanter round 26 oz 1/box
H: 270 mm/10 5/8"

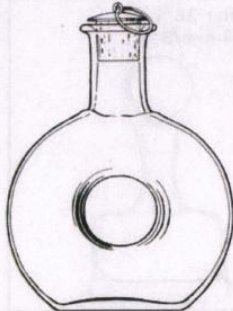

88060-2
Karaff 4-kantig 100 cl 1/kart.
Decanter square 35 oz 1/box
H: 280 mm/11"

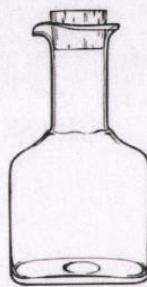



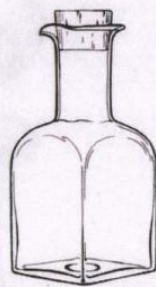

88061-2
Karaff romb 75 cl 1/kart.
Decanter rhomb 26 oz 1/box
H: 255 mm/10"



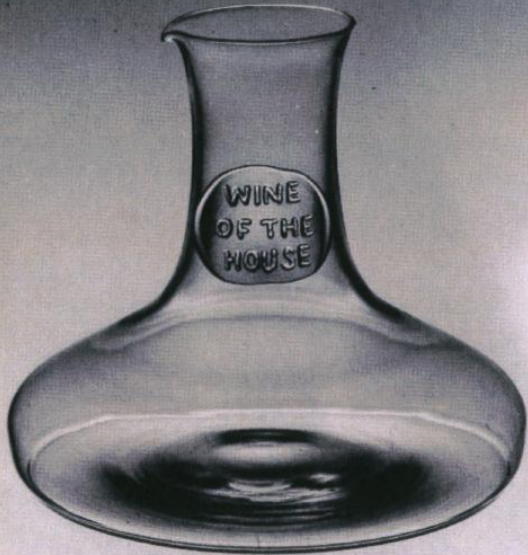

Boda Karaffer Boda Decanter

Design:
Bengt Edenfalk

	<p>88203-5 Karaff 80 cl Wine decanter 28 oz H: 210 mm/8 1/4"</p> 	<p>88207-5 Karaff 80 cl Wine decanter 28 oz H: 170 mm/6 5/8"</p> 
	<p>88208-5 Karaff 160 cl Wine decanter 56 oz H: 205 mm/8"</p> 	

Boda Victoria

	<p>88135-3 Karaff 50 cl Decanter 17 oz H: 200 mm/7 7/8"</p> 	
	<p>88136-3 Karaff 135 cl Decanter 47 oz H: 250 mm/9 7/8"</p> 	

Div. glas
Miscellaneous

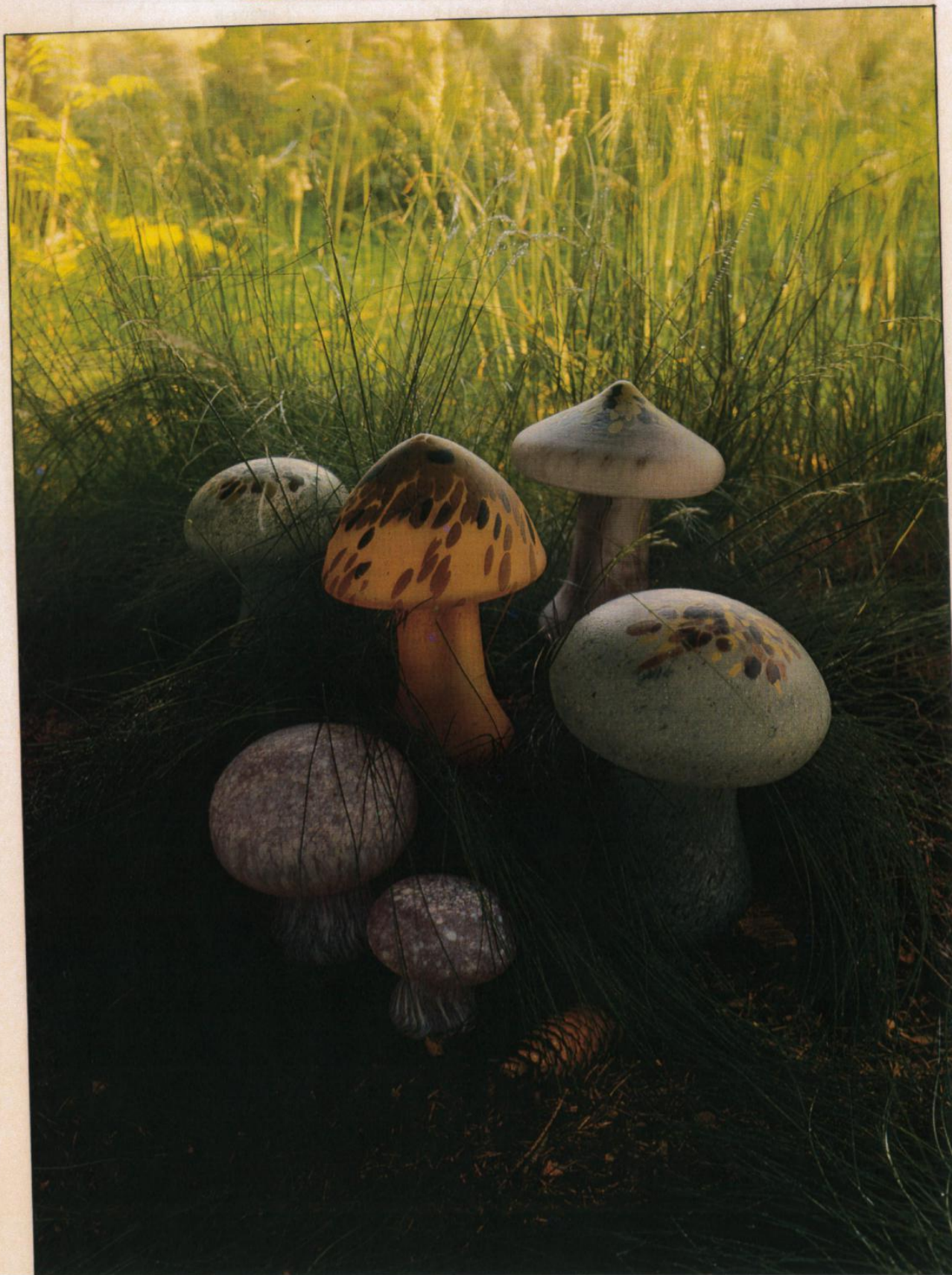

Crystal

Design:
Paul Hoff

Kosta Blåval/Haj Kosta Bluewhale/Shark

97718-1
Blåval liten
Bluewhale small
L: 205 mm/8"

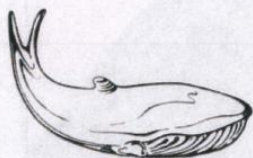

97719-1
Blåval stor
Bluewhale large
L: 255 mm/10"



98032-1
Haj
Shark
L: 300 mm/11³/₄"



98033-1
Haj
Shark
L: 400 mm/15³/₄"



Crystal

Design:
Vicke Lindstrand

Kosta Dalecarlia

92394-1
Vinglas 1/kart.
Wineglass 1/box
H: 160 mm/6¹/₄"



96366-1
Sejdel 60 cl
Mug 21¹/₁₀ oz
H: 120 mm/4³/₄"
Ø: 95 mm/3³/₄"



**Kosta Isblock
Kosta Icebergs**



90001-1
Isblock "Ren"
Iceberg "Reindeer"
L: 100 mm/4"
H: 110 mm/4³/₈"



90003-1
Isblock "Ren"
Iceberg "Reindeer"
L: 200 mm/7⁷/₈"
H: 155 mm/6¹/₈"

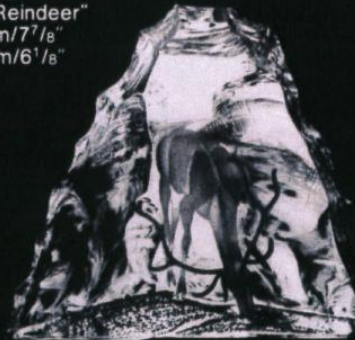

90006-1
Isblock "Lapp och Ren"
Iceberg "Laplander and
Reindeer"
L: 245 mm/9⁵/₈"
H: 150 mm/5⁷/₈"



90009-1
Isblock "Vandrande björnar"
Iceberg "Wandering Polar
Bears"
L: 100 mm/4"
H: 90 mm/3¹/₂"

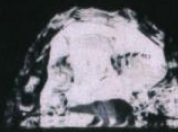

Kosta Isblock

90010-1
Isblock "Vandrande björnar"
Iceberg "Wandering Polar
Bears"
L: 140 mm/5¹/₂"
H: 95 mm/3³/₄"



90011-1
Isblock "Vandrande björnar"
Iceberg "Wandering Polar
Bears"
L: 195 mm/7⁵/₈"
H: 120 mm/4³/₄"



90012-1
Isblock "Vandrande björnar"
1/kart.
Iceberg "Wandering Polar
Bears" 1/box
L: 250 mm/9⁷/₈"
H: 145 mm/5³/₄"

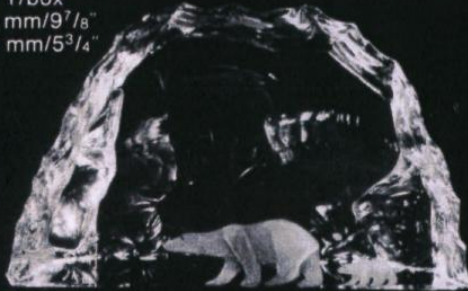

90013-1
Isblock "Vandrande björnar"
Iceberg "Wandering Polar
Bears"
L: 285 mm/11¹/₄"
H: 170 mm/6⁵/₈"



90016-1
Isblock "Simmande björn"
Iceberg "Swimming Polar
Bear"
L: 225 mm/8⁷/₈"
H: 175 mm/6⁷/₈"



90019-1
Isblock "Simmande björn+
björn på baksidan"
Iceberg "Swimming Polar
Bear+Polar Bear at the
backside"
L: 280 mm/11"
H: 245 mm/9⁵/₈"



90042-1
Isblock "Simmande björn och
familj"
Iceberg "Swimming Polar
Bear and Family"
L: 285 mm/11¹/₄"
H: 235 mm/9¹/₄"



90044-1
Isblock "Två simmande
björnar"
Iceberg "Two Swimming
Polar Bears"
L: 300 mm/11³/₄"
H: 205 mm/8"

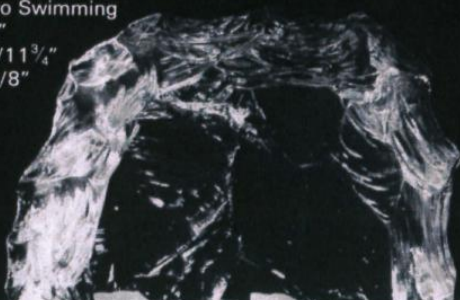

Kosta Isblock

90046-1
Isblock "Simmande säl"
1/kart.
Iceberg "Swimming Seal"
1/box
L: 210 mm/8¹/₄"
H: 140 mm/5¹/₂"



90078-1
Isblock "Segelbåt"
Iceberg "Sailboat"
L: 170 mm/6³/₈"
H: 190 mm/7¹/₂"



97676-1
Isblock "Vikingaskepp"
Iceberg "Viking Ship"
L: 190 mm/7¹/₂"
H: 125 mm/4⁷/₈"



Crystal

Design:
Mats Jonasson

**Kosta Block
Kosta Blocks**

93153-1
Block Isbjörnar 1/kart.
Block Polar Bears 1/box
H: 130 mm/5 1/8"
L: 200 mm/7 7/8"

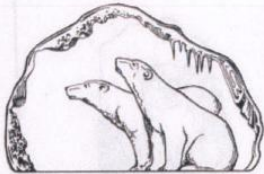

93155-1
Block Valrossar 1/kart.
Block Walrusses 1/box
H: 160 mm/6 1/4"
L: 250 mm/9 7/8"



93170-1
Block Puma 1/kart.
Block Puma 1/box
H: 170 mm/6 5/8"
L: 220 mm/8 5/8"



93175-1
Block Knipa 1/kart.
Block Duck 1/box
H: 85 mm/3 3/8"



93176-1
Block Skrakar 1/kart.
Block Ducks 1/box
H: 110 mm/4 3/8"
L: 205 mm/8"



93177-1
Block Svan 1/kart.
Block Swan 1/box
H: 105 mm/4 1/8"
L: 170 mm/6 5/8"



93178-1
Block Svanar 1/kart.
Block Swans 1/box
H: 130 mm/5 1/8"
L: 200 mm/7 7/8"



93179-1
Block Häger 1/kart.
Block Heron 1/box
H: 180 mm/7 1/8"



93190-1
Block Vikingaskepp 1/kart.
Block Viking Ship 1/box
H: 140 mm/5 1/2"
L: 240 mm/9 1/2"



93191-1
Block S:ta Maria 1/kart.
Block Santa Maria 1/box
H: 140 mm/5 1/2"
L: 230 mm/9"



Kosta Block Kosta Blocks

Crystal

Design:
Mats Jonasson

93192-1
Block Caravelle 1/kart.
Block Caravelle 1/box
H: 140 mm/5 1/2"
L: 240 mm/9 1/2"



93193-1
Block Zebra 1/kart.
Block Zebra 1/box
H: 185 mm/7 1/4"
L: 250 mm/9 7/8"



93194-1
Block Zebraföi 1/kart.
Block Zebra foal 1/box
H: 115 mm/4 1/2"
L: 150 mm/5 7/8"



93196-1
Block Lejon 1/kart.
Block Lion 1/box
H: 225 mm/8 7/8"



93197-1
Block Lejonungar 1/kart.
Block Young Lions 1/box
H: 100 mm/4"
L: 130 mm/5 1/8"



93198-1
Block Gasell
Block Gazelle
H: 145 mm/5 3/4"
L: 180 mm/7 1/8"



93250-1
Block Kid 1/kart.
Block Fawn 1/box
H: 115 mm/4 1/2"



93251-1
Block Rådjur m. kid 1/kart.
Block Roe with Fawn 1/box
H: 150 mm/5 7/8"



93252-1
Block Kronhjort 1/kart.
Block Deer 1/box
H: 205 mm/8"



93253-1
Block Älg 1/kart.
Block Moose 1/box
H: 210 mm/8 1/4"



93254-1
Block Hare 1/kart.
Block Rabbit 1/box
H: 90 mm/3 1/2"



93255-1
Block Ekorre 1/kart.
Block Squirrel 1/box
H: 155 mm/6 1/8"



93256-1
Block Lejonfamilj 1/kart.
Block Lion Family 1/box
H: 160 mm/6 1/4"
L: 320 mm/12 1/2"



Kosta Brevpressar Kosta Paper weights

Crystal

Design:
Mats Jonasson



99150-1
Entita 1/kart.
Marsh-tit 1/box
Ø: 90 mm/3 1/2"



99151-1
Nötväcka 1/kart.
Nuthatch 1/box
Ø: 90 mm/3 1/2"



99152-1
Kungsfågel 1/kart.
Goldcrest 1/box
Ø: 90 mm/3 1/2"



99153-1
Gärdsmyg 1/kart.
Wren 1/box
Ø: 90 mm/3 1/2"



99154-1
Domherre 1/kart.
Bullfinch 1/box
Ø: 100 mm/4"



99155-1
Sidensvans 1/kart.
Waxwing 1/box
Ø: 100 mm/4"



99160-1
Bergfink 1/kart.
Brambling 1/box
Ø: 95 mm/3 3/4"



99161-1
Blåmes 1/kart.
Blue tit 1/box
Ø: 95 mm/3 3/4"



99162-1
Kustpipare 1/kart.
Grey Plover 1/box
Ø: 95 mm/3 3/4"



99163-1
Lövsångare 1/kart.
Willow Warbler 1/box
Ø: 95 mm/3 3/4"



Crystal

Design:
Mats Jonasson

Kosta Brevpressar Kosta Paper weights

99164-1
Rörsångare 1/kart.
Reed warbler 1/box
Ø: 95 mm/3 3/4"



99165-1
Svart-vit Flugsnappare 1/kart.
Pied Flycatcher 1/box
Ø: 95 mm/3 3/4"



99166-1
Tofsvipekyckling 1/kart.
Lapwing Chick 1/box
Ø: 85 mm/3 3/8"



99167-1
Trädkrypare 1/kart.
Treecreeper 1/box
Ø: 85 mm/3 3/8"



99171-1
Fjäril Apollo 1/kart.
Butterfly Apollo 1/box
Ø: 90 mm/3 1/2"



99172-1
Fjäril Polygonia 1/kart.
Butterfly Polygonia 1/box
Ø: 90 mm/3 1/2"



99173-1
Fjäril Spinnare 1/kart.
Butterfly 1/box
Ø: 90 mm/3 1/2"

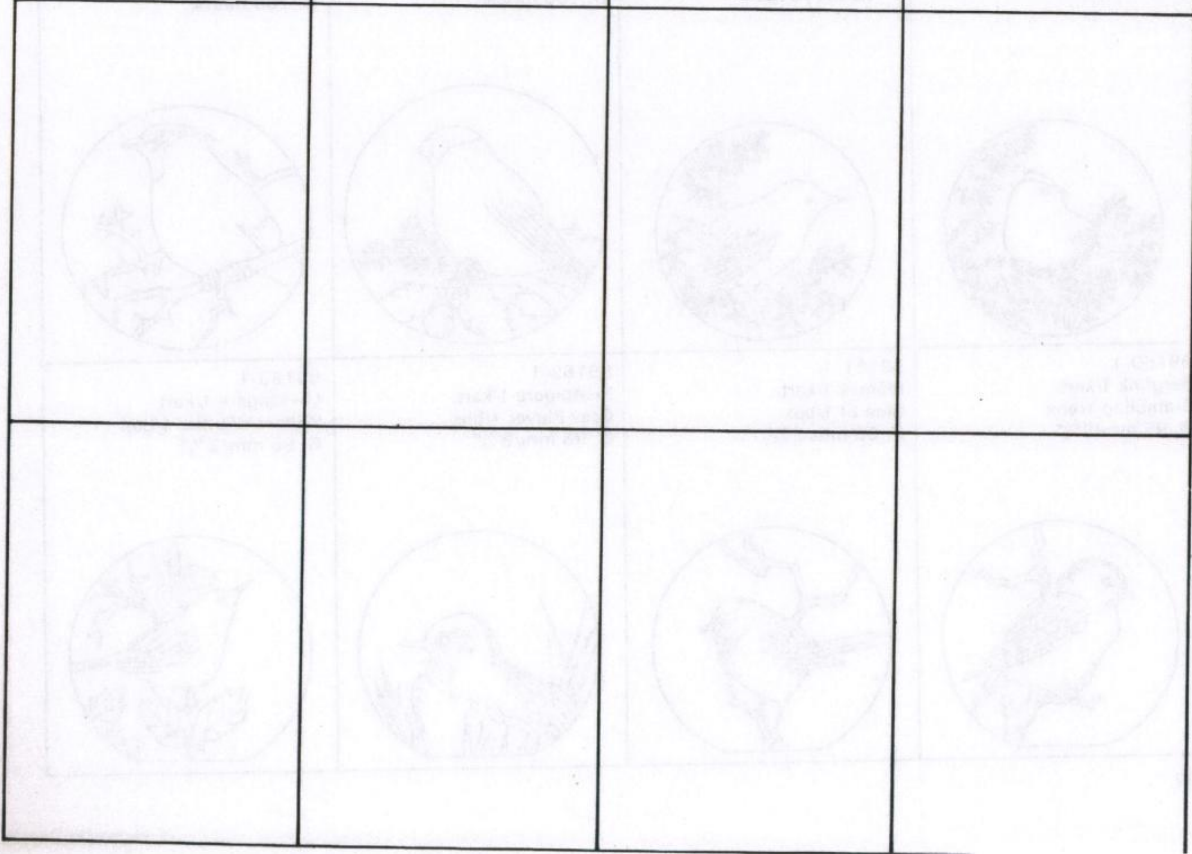

Kosta Brevpressar Kosta Paper weights

Crystal

Design:
Folke Walwing



93050-1
Äpple 1/kart.
Apple 1/box
H: 85 mm/3³/₈"

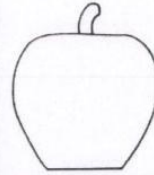

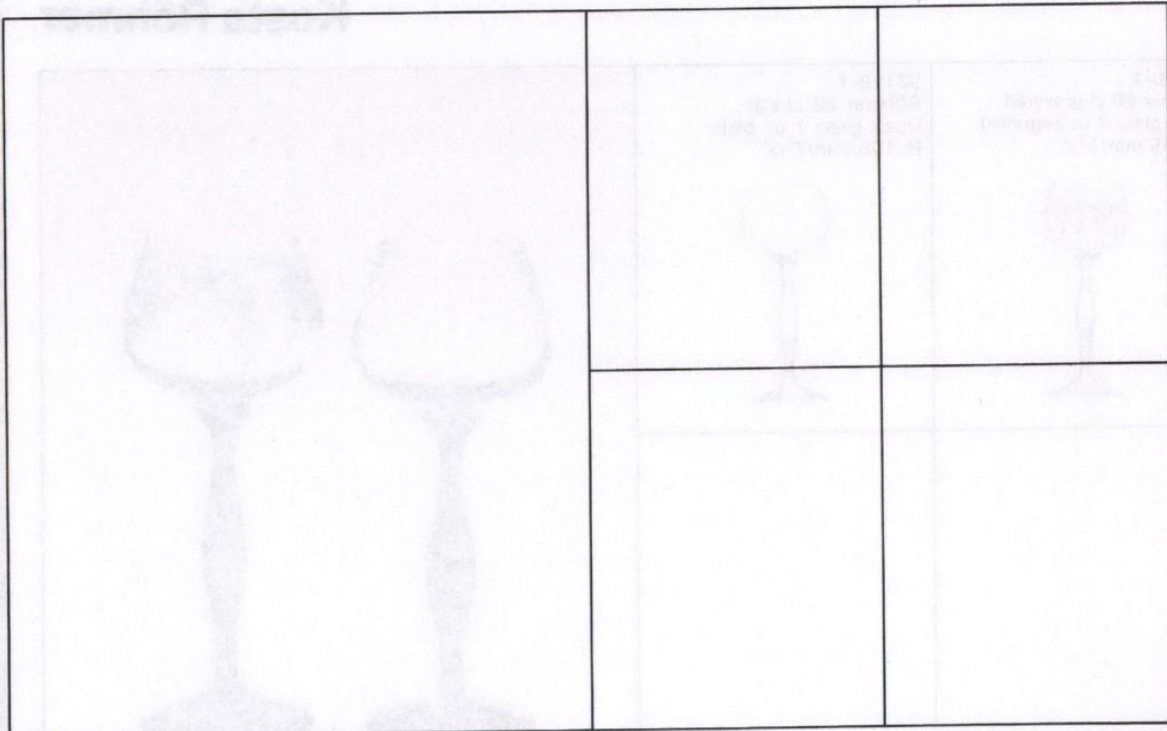

93051-1
Päron 1/kart.
Pear 1/box
H: 125 mm/4⁷/₈"





Crystal

Design:
Wärff

Kosta Brevpress Månblomma Kosta Paperweight Moon-flower

	<p>96899-1 Brevpress "Månblomma" Paperweight "Moonflower" H: 85 mm/3³/₈"</p> 	
	<p>97070-1 Brevpress "Månblomma" blå/gröna slingor Paperweight "Moonflower" blue/green coils H: 145 mm/5³/₄"</p> 	

Kosta Röhmer

<p>93108-1 Röhmer 20 cl graverad Hock glass 7 oz engraved H: 195 mm/7⁵/₈"</p> 	<p>93118-1 Röhmer 20 cl slät Hock glass 7 oz plain H: 195 mm/7⁵/₈"</p> 	

Kosta Prisma Kosta Prism

Crystal

Design:
Vicke Lindstrand

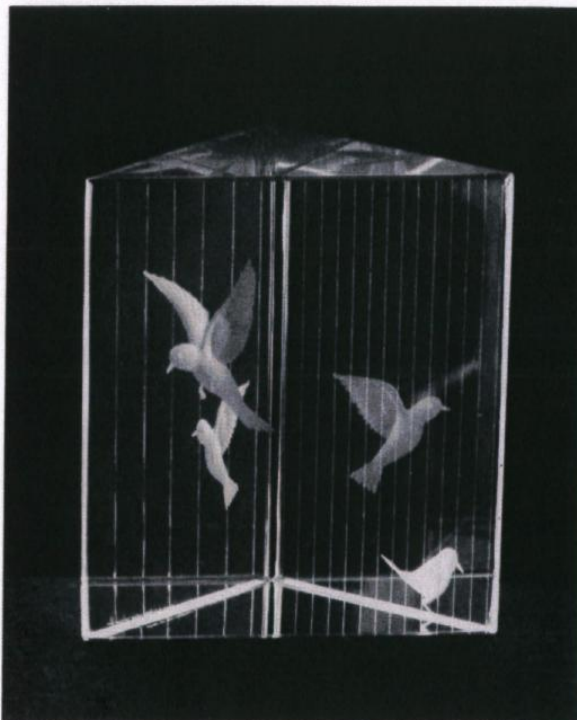

92412-1
Prisma "Träd och Hjortar"
Prism "Deer-park"
H: 170 mm/6 7/8"



92415-1
Prisma "Fågelbur" 1/kart.
Prism "Birdcage" 1/box
H: 100 mm/4"



97105-1
Prisma "Fiskstim"
Prism "Shoal of Fish"
H: 100 mm/4"



97257-1
Prisma "Balett"
Prism "Ballet"
H: 100 mm/4"



Kosta Sails

Crystal

Design:
Göran Wärff



98001-1
Vriden skulptur på sockel
1/kart.
Twisted sculpture on wooden
stand 1/box
H: 90 mm/3 1/2"
Ø: 75 x 75 mm/3 x 3"



98002-1
Vriden skulptur på sockel
Twisted sculpture on wooden
stand
H: 175 mm/6 7/8"
Ø: 75 x 75 mm/3 x 3"

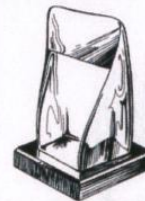

98003-1
Vriden skulptur på sockel
Twisted sculpture on wooden
stand
H: 130 mm/5 1/8"
Ø: 95 x 95 mm/3 3/4 x 3 3/4"



Crystal

Design:
Mats Jonasson

Kosta Skulpturer Kosta Sculptures



93056-1
Figur Uggla 1/kart.
Figurine Owl 1/box
H: 110 mm/4 3/8"



93057-1
Figur Uggla 1/kart.
Figurine Owl 1/box
H: 150 mm/5 7/8"



93068-1
Figur Panda 1/kart.
Figurine Panda 1/box
H: 145 mm/5 3/4"



93137-1
Figur Adam 1/kart.
Figurine Adam 1/box
H: 105 mm/4 1/8"



93138-1
Figur Eva 1/kart.
Figurine Eve 1/box
H: 105 mm/4 1/8"



93141-1
Figur Lejon 1/kart.
Figurine Lion 1/box
H: 140 mm/5 1/2"



93142-1
Figur Lejon 1/kart.
Figurine Lion 1/box
H: 200 mm/7 7/8"













93146-1
Figur Tiger 1/kart.
Figurine Tiger 1/box
H: 150 mm/5 7/8"



Kosta Skulpturer Kosta Sculptures

Crystal

Design:
Mats Jonasson

<p>93147-1 Figur Grävling 1/kart. Figurine Badger 1/box H: 90 mm/3½"</p> 	<p>93148-1 Figur Igelkott 1/kart. Figurine Hedgehog 1/box H: 55 mm/2 ⅛"</p> 	<p>93149-1 Figur Igelkott 1/kart. Figurine Hedgehog 1/box H: 75 mm/3"</p> 	<p>93180-1 Figur Påfågel 1/kart. Figurine Peacock 1/box H: 185 mm/7 ¼"</p> 
<p>93181-1 Figur Påfågel 1/kart. Figurine Peacock 1/box H: 230 mm/9"</p> 	<p>93182-1 Figur Lejon 1/kart. Figurine Lion 1/box H: 130 mm/5 ⅛"</p> 	<p>93183-1 Figur Lejon 1/kart. Figurine Lion 1/box H: 175 mm/6 ⅞"</p> 	<p>93184-1 Figur Flodhäst 1/kart. Figurine Hippopotamus 1/box H: 130 mm/5 ⅛"</p> 
<p>93185-1 Figur Teddybjörn 1/kart. Figurine Coala Bear 1/box H: 120 mm/4¾"</p> 	<p>93186-1 Figur Teddybjörn 1/kart. Figurine Coala Bear 1/box H: 95 mm/3¾"</p> 		

Crystal

Design:
Göran Wärrff

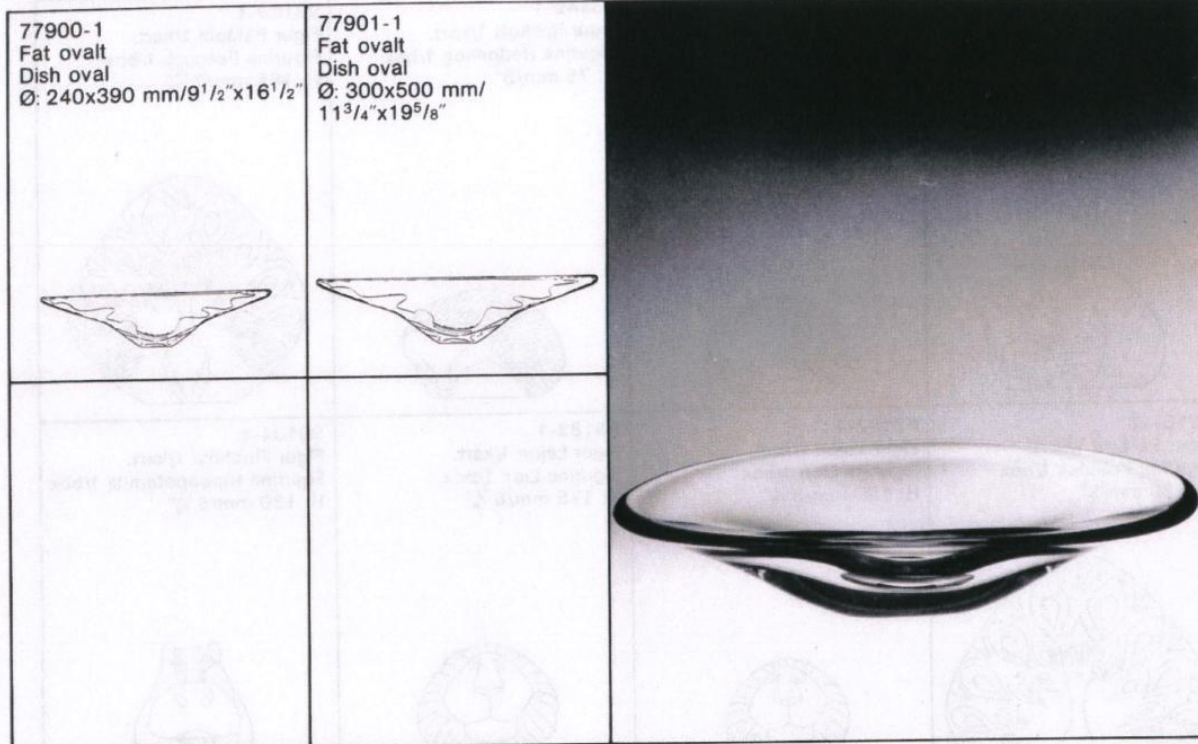

Crystal

Design:
Paul Hoff

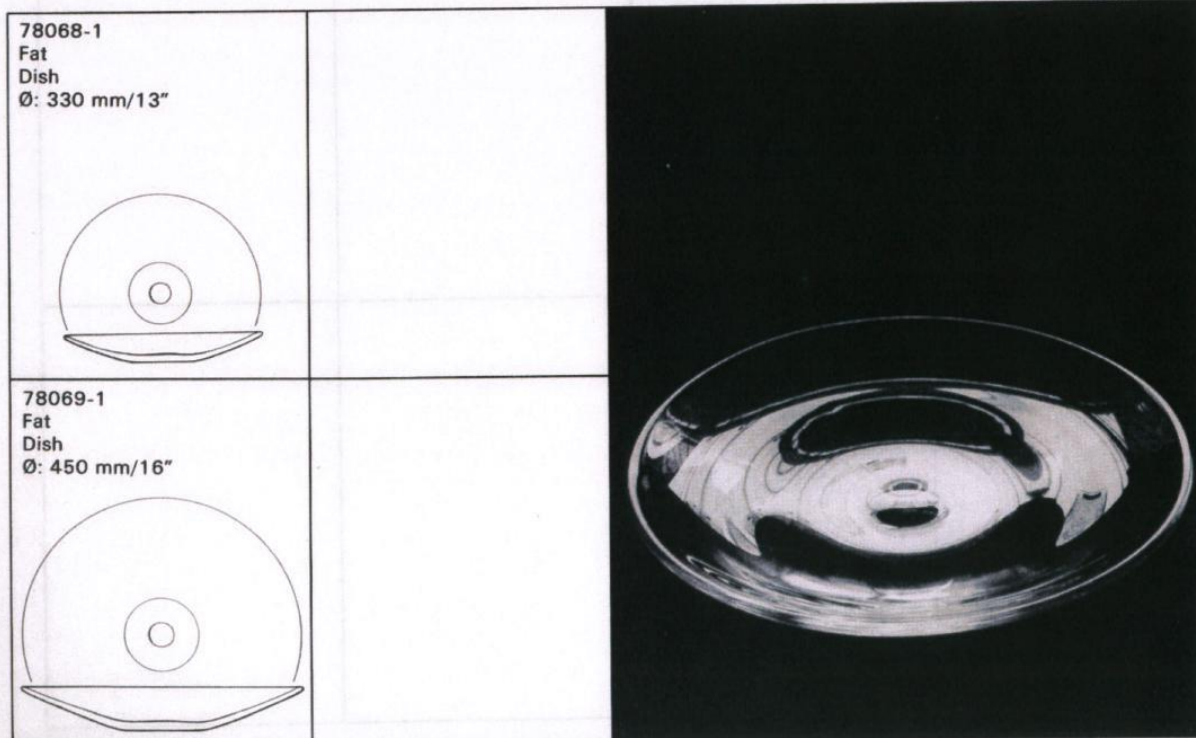

Kosta Julie

Design:
Ann Wärff



77710-1
Fat
Dish
Ø: 290 mm/11³/₈"

Kosta Fat Symfoni Kosta Dish Symphony

Crystal

Design:
Mats Jonasson

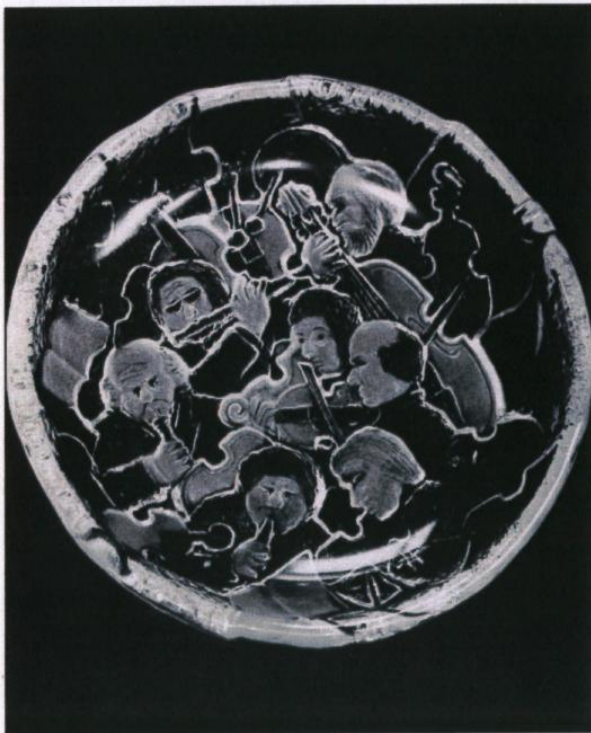







77167-1
Fat
Dish
Ø: 255 mm/10"



Design:
Monica Backström

Boda Seashell

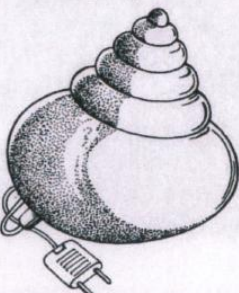

<p>98123-2 Snäcka röd 1/kart. Shell red 1/box H: 60 mm/2³/₈"</p> 	<p>98124-2 Snäcka blå 1/kart. Shell blue 1/box H: 90 mm/3¹/₂"</p> 	<p>98125-2 Snäcka röd 1/kart. Shell red 1/box H: 100 mm/4"</p> 	<p>98126-2 Snäcka blå 1/kart. Shell blue 1/box H: 125 mm/4⁷/₈"</p> 
<p>98127-2 Snäcka röd 1/kart. Shell red 1/box H: 130 mm/5¹/₈"</p> 	<p>98128-2 Mussla röd 1/kart. Shell red 1/box H: 120 mm/4³/₄"</p> 	<p>98129-2 Lampa Snäcka blå Lamp Shell blue H: 180 mm/7¹/₈" Ø: 180 mm/7¹/₈"</p> 	<p>98130-2 Lampa Snäcka röd Lamp Shell red H: 180 mm/7¹/₈" Ø: 180 mm/7¹/₈"</p> 

Boda Black & White

Design:
Ulrica
Hydman-Vallien



97973-3
Vin 7¹/₂ cl 2/kart.
Wine 2³/₅ oz 2/box
H: 215 mm/8¹/₂"
Ø: 75 mm/3"

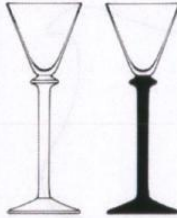

Boda Classic

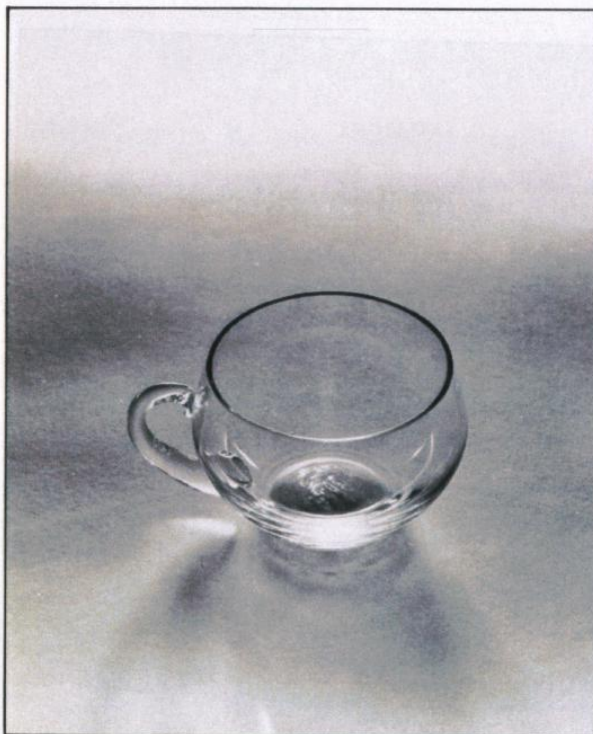

93111-2
Boda "Classic Punsch" 8 cl
4/kart.
Boda "Classic Punsch"
2⁴/₅ oz 4/box
H: 45 mm/1³/₄"

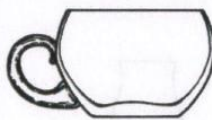

Design:
Bertil Vallien

20405-3
Vin 1/kart.
Wine 1/box
H: 175 mm/6 7/8"



87800-3
Kanna 100 cl 1/kart.
Jug 35 1/10 oz 1/box



Design:
Arne Branzell

97725-4
Boda Likör 10 cl 2/kart.
Boda Liqueur 3 1/2 oz 2/box
H: 120 mm/4 3/4"
Ø: 69 mm/2 3/4"



97726-4
Boda Cognac 15 cl 2/kart.
Boda Cognac 5 3/10 oz 2/box
H: 120 mm/4 3/4"
Ø: 56 mm/2 1/8"





97880-4
"Boda Martini" 2/kart.
"Boda Martini" 2/box
H: 145 mm/5 3/4"
Ø: 88 mm/3 1/2"



87721-4
Boda Rödvinskaraff 75 cl
1/kart.
Boda Decanter - redwine
26 3/5 oz 1/box
H: 205 mm/8"



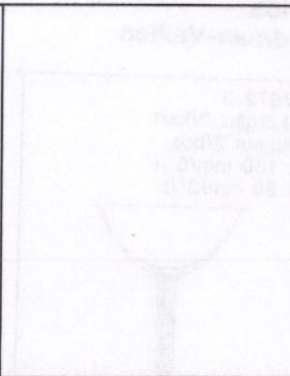

Boda Folklore

	<p>23896-4 Glögg 10 cl 2/kart. Hot wine 3 1/2 oz 2/box H: 50 mm/2" Ø: 50 mm/2"</p>	
		

Boda Sparkling

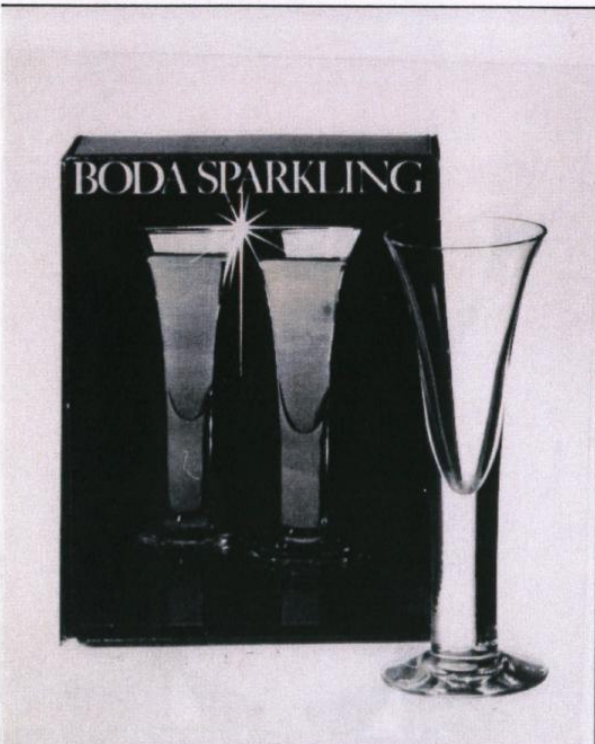
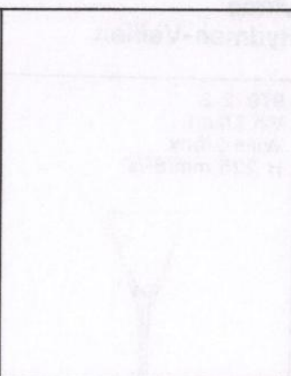
Design:
Signe Persson-Melin

	<p>94187-2 Champ/vin 15 cl 2/kart. Champ/wine 5 3/10 oz 2/box H: 210 mm/8 1/4" Ø: 70 mm/2 3/4"</p>	
		

Design:
Ulrica
Hydman-Vallien

Boda Liqueur

97972-3
Likörglas 2/kart.
Liqueur 2/box
H: 130 mm/5¹/₈"
Ø: 90 mm/3¹/₂"

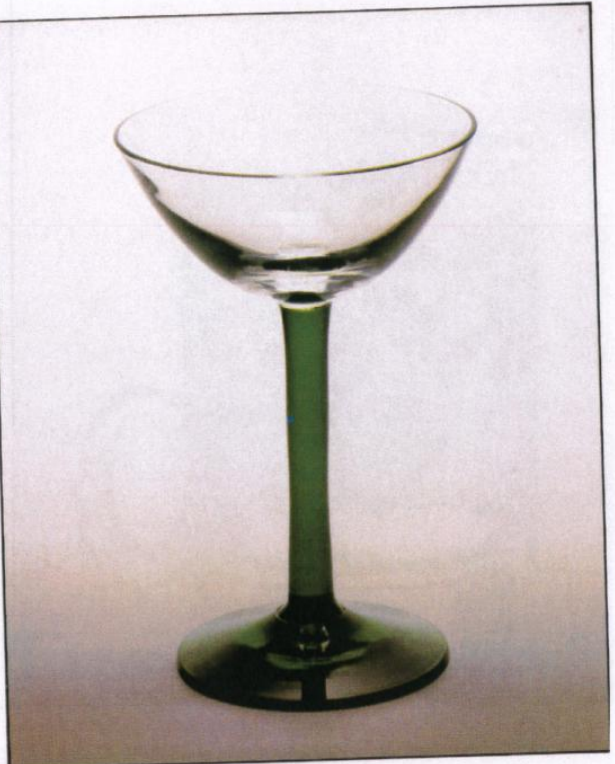

Design:
Ulrica
Hydman-Vallien

Boda Mosel

97912-3
Vin 2/kart.
Wine 2/box
H: 225 mm/8⁷/₈"



87911-3
Kanna
Jug
H: 250 mm/9⁷/₈"



Boda Provence

Design:
Marianne Westman



99031-5
Ostknapp Provence 2/kart.
Cheese grips Provence 2/box
Ø: 35 mm/1 3/8"



99032-5
Knivlägg Provence 2/kart.
Knife rest Provence 2/box
Ø: 55 mm/2 1/8"



Boda Smycken Boda Pendants

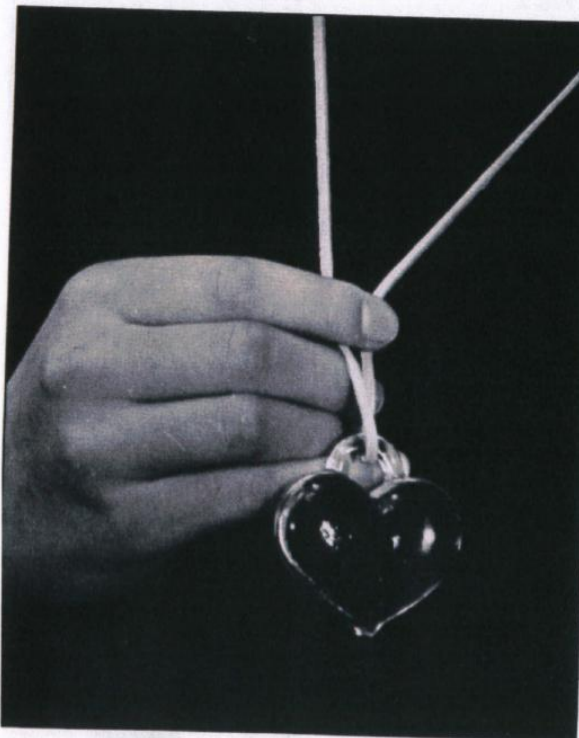

97664-3
Hjärta 12/kart.
Heart 12/box



Boda Svampar Boda Mushrooms

Design:
Monica Backström

97544-2
Svamp "Karl Johan" liten
Mushroom "Cep" small
H: 120 mm/4³/₄"



97545-2
Svamp "Karl Johan" stor
Mushroom "Cep" large
H: 155 mm/6¹/₈"



97771-2
Svamp "Snöbollchampignon"
1/kart.
Mushroom "Snöbollcham-
pignon" 1/box
H: 130 mm/5¹/₈"



97772-2
Svamp "Snöbollchampignon"
Mushroom "Snöbollcham-
pignon"
H: 180 mm/7¹/₈"

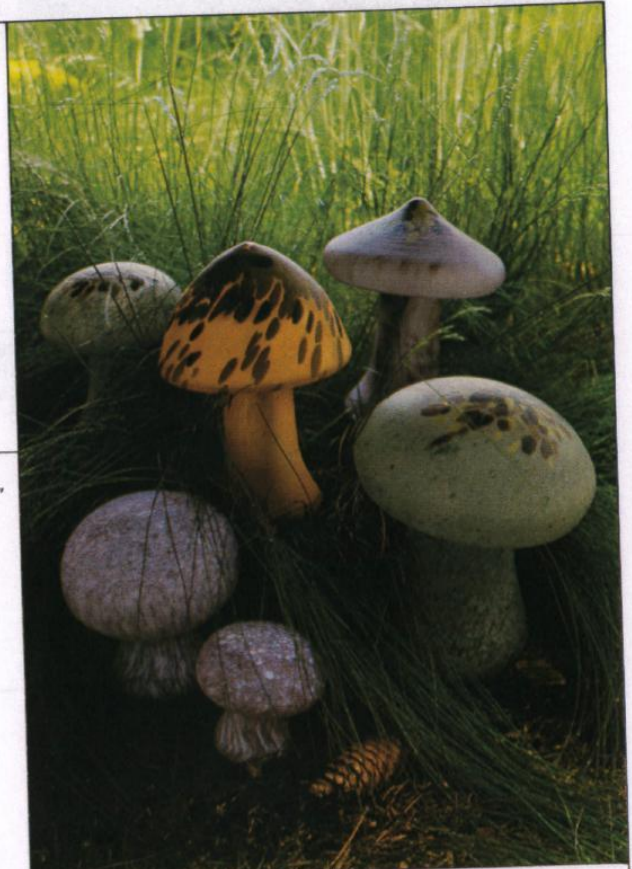

97776-2
Svamp "Vaxskivling" 1/kart.
Mushroom "Agaric" 1/box
H: 110 mm/4³/₈"



97777-2
Svamp "Vaxskivling"
Mushroom "Agaric"
H: 185 mm/7¹/₄"



97778-2
Svamp "Vaxskivling"
Mushroom "Agaric"
H: 265 mm/10³/₈"



97779-2
Svamp "Brun Karl-Johan"
1/kart.
Mushroom "Cep brown"
1/box
H: 120 mm/4³/₄"



97780-2
Svamp "Brun Karl-Johan"
Mushroom "Cep brown"
H: 155 mm/6¹/₈"



97781-2
Svamp "Brun Karl-Johan"
Mushroom "Cep brown"
H: 260 mm/10¹/₄"



97803-2
Lampa "Vaxskivling"
Lamp "Agaric"
H: 185 mm/7¹/₄"













97804-2
Lampa "Brun Karl-Johan"
Lamp "Cep brown"
H: 260 mm/10¹/₄"

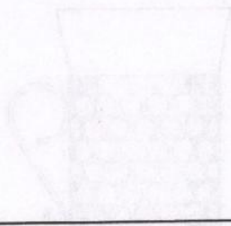
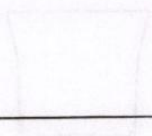
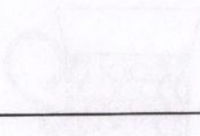
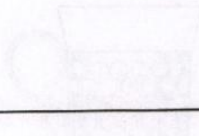

Boda Svampar Boda Mushrooms

Design:
Monica Backström

<p>97809-2 Lampa "Vaxskivling" Lamp "Agaric" H: 265 mm/10³/₈"</p> 	<p>97915-2 Lampa "Snöbollchampignon" Mushroom-lamp H: 260 mm/10¹/₄"</p> 	<p>97947-2 Svamlampa rosa Mushroom-lamp pink H: 180 mm/7¹/₈"</p> 	<p>97948-2 Svamlampa rosa Mushroom-lamp pink H: 350 mm/13³/₄"</p> 
<p>97949-2 Svamlampa brun Mushroom-lamp brown H: 350 mm/13³/₄"</p> 	<p>98023-2 Lampa "Brun Karl-Johan" Lamp "Cep brown" H: 150 mm/5⁷/₈"</p> 		
			
			

Boda Varmdrycksglas Boda Hot drinks

Design:
Kjell Blomberg



92505-5
Glöggglas krom 2/kart.
Hot wine crome 2/box
H: 60 mm/2³/₈"

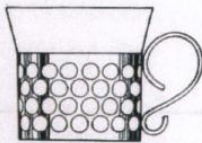

92506-5
Glöggglas guld 2/kart.
Hot wine gold 2/box
H: 60 mm/2³/₈"

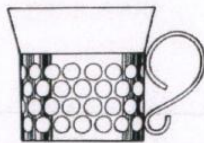

92524-5
Löst glas glögg
Spare glass Hot wine
H: 60 mm/2³/₈"

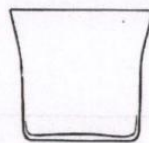

92507-5
Irish Coffee krom 2/kart.
Irish Coffee crome 2/box
H: 95 mm/3³/₄"

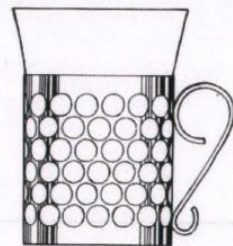

92508-5
Irish Coffee guld 2/kart.
Irish Coffee gold 2/box
H: 95 mm/3³/₄"

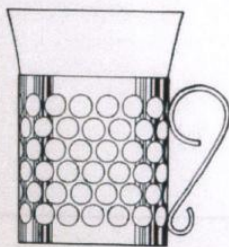

92522-5
Löst glas Irish Coffee
Spare glass Irish Coffee
H: 95 mm/3³/₄"



Ateljéglas är glaskonstverk som framställs i en begränsad upplaga och där varje exemplar är signerat av konstnären.

En pjäs kan aldrig bli en annan helt lik, trots att grundformen är densamma. Ateljé-glaset skapas ju för hand i hyttan. Det munblåses av mästaren och formas av yrkesskickliga händer efter konstnärens intentioner.

Man skulle kunna säga, att ateljé-glaset är ett mellanting mellan unika glaspjäser och serietillverkade.

Studioglass is a piece of art produced in a limited edition, each piece being individually signed by the artist.

No pieces are alike although the original shapes are the same. Studioglass is handmade and formed by the glassmaster's skilled hand, after the intentions of the artist.

One could say that studioglass is in between a unique piece of glass and a piece of glass in normal production.

Crystal

Design:
Anna Ehrner

Kosta Crystal Art



48118-1
Vas rosa
Vase pink
H: 140 mm/5 1/2"



58118-1
Skål rosa
Bowl pink
Ø: 85 mm/3 3/8"



58119-1
Skål rosa
Bowl pink
Ø: 125 mm/4 7/8"

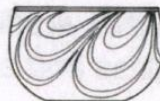

58120-1
Skål rosa
Bowl pink
Ø: 160 mm/6 1/4"



58121-1
Skål rosa
Bowl pink
Ø: 195 mm/7 5/8"

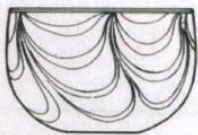

98118-1
Pokal vit
Cup white
H: 170 mm/6 5/8"



98119-1
Pokal vit
Cup white
H: 240 mm/9 1/2"





48122-1
Vas lila
Vase lilac
H: 165 mm/6 1/2"



58122-1
Skål lila
Bowl lilac
H: 90 mm/3 1/2"
Ø: 115 mm/4 1/2"



58123-1
Skål lila
Bowl lilac
H: 120 mm/4 3/4"
Ø: 140 mm/5 1/2"

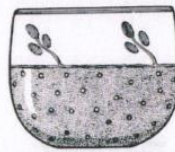

78122-1
Fat lila
Dish lilac
Ø: 300 mm/11 3/4"

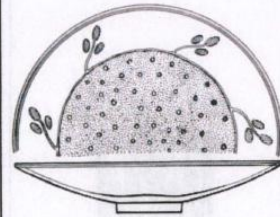

Crystal

Design:
Klas-Göran Tinbäck

Kosta Crystal Art



48124-1
Vas blå
Vase blue
H: 135 mm/5 ³/₈"



58124-1
Skål blå
Bowl blue
H: 65 mm/2 ¹/₂"
Ø: 110 mm/4 ³/₈"



58125-1
Skål blå
Bowl blue
H: 85 mm/3 ³/₈"
Ø: 140 mm/5 ¹/₂"



58126-1
Skål blå
Bowl blue
H: 100 mm/4"
Ø: 200 mm/7 ⁷/₈"



58127-1
Skål blå
Bowl blue
H: 110 mm/4 ³/₈"
Ø: 250 mm/9 ⁷/₈"





97934-1
Droppe mörk sockel
Drop dark wooden stand
H: 210 mm/8¹/₄"

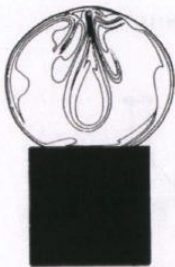

97935-1
Vit droppe mörk sockel
White drop dark wooden stand
H: 210 mm/8¹/₄"



97937-1
Oval ljus sockel
Oval light wooden stand
H: 265 mm/10³/₈"



97939-1
Färgad droppe mörk sockel
Colored drop dark wooden stand
H: 210 mm/8¹/₄"



98025-1
Skulptur m. tvillingbubblor
Globe with twin bubbles
H: 160 mm/6¹/₄"



98026-1
Spegelkula på sockel
Mirror-globe/wooden stand
H: 170 mm/6⁵/₈"



98027-1
Skulptur konisk
Sculpture conical
H: 200 mm/7⁷/₈"



Boda Artist Collection

Boda Antikva

Design:
Bertil Vallien

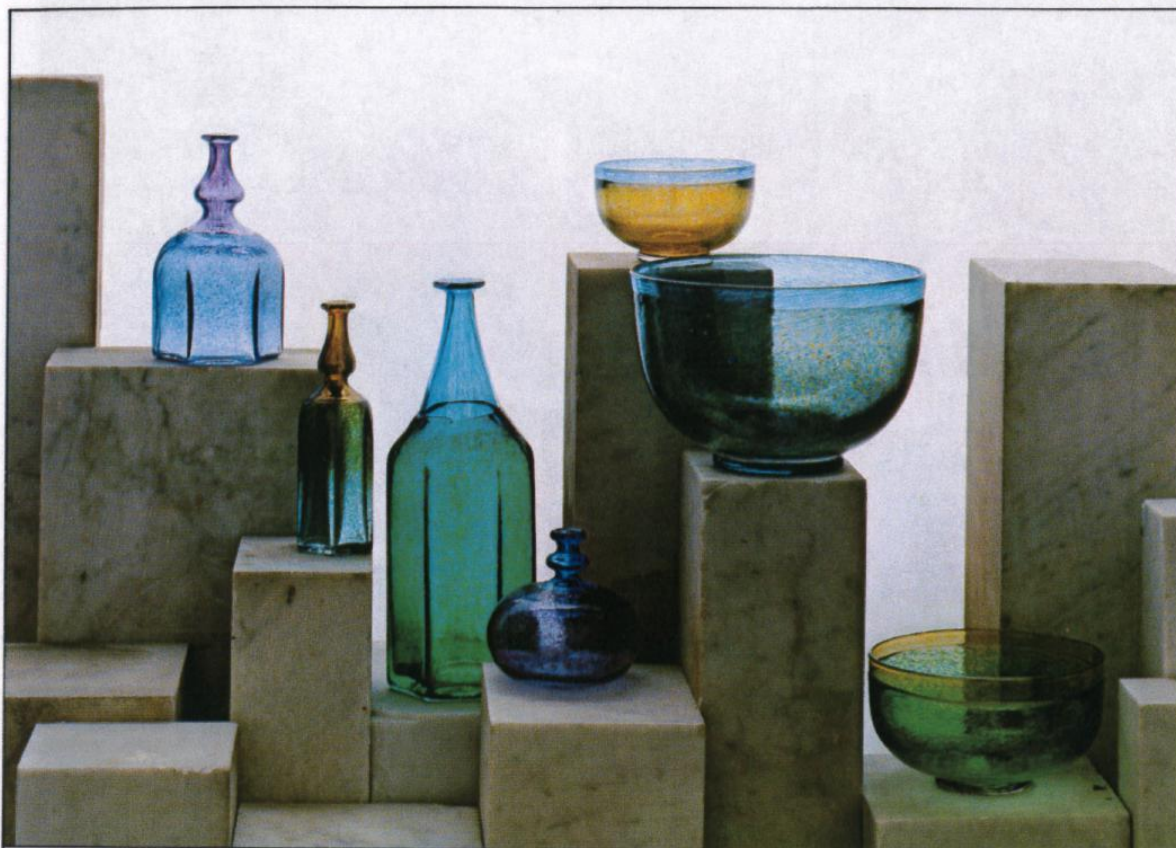

47836-3
Flaska
Bottle
H: 100 mm/4"



47835-3
Flaska
Bottle
H: 150 mm/5⁷/₈"



47834-3
Flaska
Bottle
H: 165 mm/6¹/₂"



47865-3
Flaska
Bottle
H: 260 mm/10¹/₄"



47866-3
Flaska
Bottle
H: 280 mm/11"



57834-3
Skál
Bowl
Ø: 100 mm/4"



57835-3
Skál
Bowl
Ø: 140 mm/5¹/₂"







57865-3
Skál
Bowl
Ø: 175 mm/6⁷/₈"

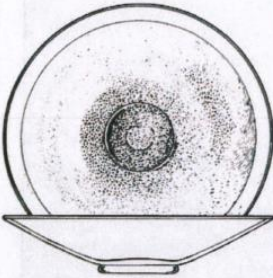

Boda Artist Collection

Boda Antikva

Design:
Bertil Vallien

<p>77865-3 Fat Dish Ø: 290 mm/11³/₈"</p> 	<p>48008-3 Miniatur Miniature Vas 1/kart. Vase 1/box H: 55 mm/2¹/₈"</p> 	<p>48009-3 Miniatur Miniature Flaska 1/kart. Bottle 1/box H: 85 mm/3³/₈"</p> 	<p>48010-3 Miniatur Miniature Flaska 1/kart. Bottle 1/box H: 100 mm/4"</p> 
<p>58010-3 Miniatur Miniature Skål 1/kart. Bowl 1/box Ø: 55 mm/2" H: 45 mm/1³/₄"</p> 			

Boda Artist Collection Boda Butterfly

Design:
Ulrica
Hydman-Vallien



57911-3
Skål
Bowl
H: 100 mm/4"
Ø: 120 mm/4³/₄"



57912-3
Skål
Bowl
H: 130 mm/5¹/₈"
Ø: 170 mm/6⁵/₈"



57913-3
Skål
Bowl
H: 180 mm/7¹/₈"
Ø: 230 mm/9"



47909-3
Vas
Vase
H: 250 mm/9⁷/₈"



77911-3
Fat
Dish
Ø: 260 mm/10¹/₄"











Boda Artist Collection

Boda Galaxy

Design:
Bertil Vallien



<p>48014-3 Flaska blå Bottle blue H: 200 mm/7 ⁷/₈"</p> 	<p>48015-3 Flaska blå Bottle blue H: 260 mm/10 ¹/₄"</p> 	<p>48016-3 Flaska blå Bottle blue H: 310 mm/12 ¹/₄"</p> 	<p>48017-3 Vas blå Vase blue H: 150 mm/6 ¹/₄" Ø: 135 x 110 mm/5 ³/₈ x 4 ³/₈"</p> 
<p>58014-3 Skål rund blå Bowl round blue H: 75 mm/3" Ø: 110 mm/4 ³/₈"</p> 	<p>58015-3 Skål rund blå-gul Bowl round blue-yellow H: 125 mm/4 ⁷/₈" Ø: 180 mm/7 ¹/₈"</p> 	<p>58016-3 Skål oval blå-gul Bowl oval blue-yellow H: 95 mm/3 ³/₄" Ø: 130 x 105 mm/5 ¹/₈ x 4 ¹/₈"</p> 	<p>98014-3 Pokal blå Cup blue H: 220 mm/8 ⁵/₈" Ø: 145 mm/5 ³/₄"</p> 

Boda Artist Collection

Boda Network

Design:
Bertil Vallien

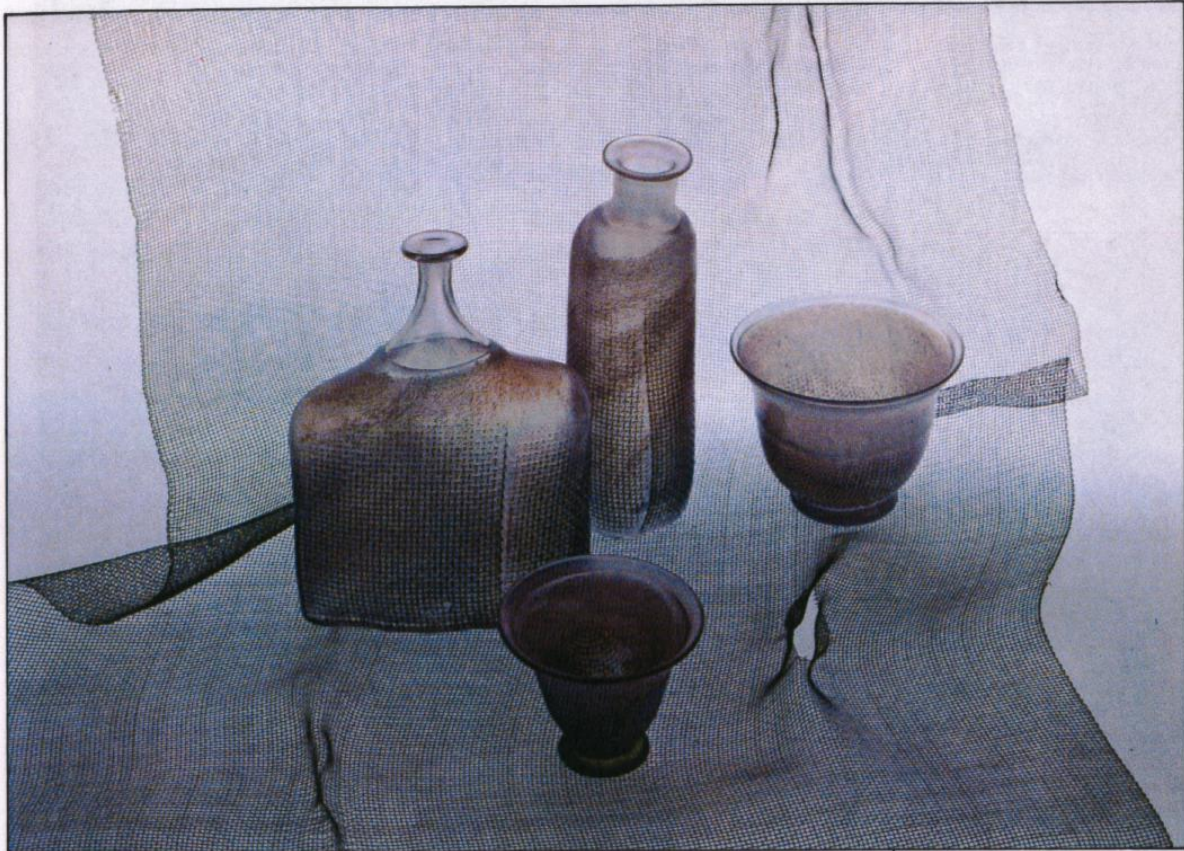

47862-3
Flaska
Bottle
H: 150 mm/5⁷/₈"

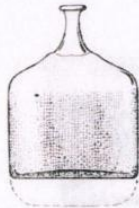

47863-3
Flaska
Bottle
H: 200 mm/7⁷/₈"

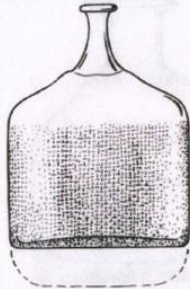

47864-3
Flaska
Bottle
H: 240 mm/9¹/₂"



57862-3
Skål
Bowl
Ø: 100 mm/4"



57863-3
Skål
Bowl
Ø: 130 mm/5¹/₈"



47966-3
Vas med blå punkt
Vase with blue dot
H: 110 mm/4³/₈"



47967-3
Vas med blå punkt
Vase with blue dot
H: 150 mm/5⁷/₈"



47968-3
Vas med blå punkt
Vase with blue dot
H: 185 mm/7¹/₄"



Boda Artist Collection

Boda Network

Design:
Bertil Vallien

47969-3
Flaska med blå punkt
Bottle with blue dot
H: 280 mm/11"

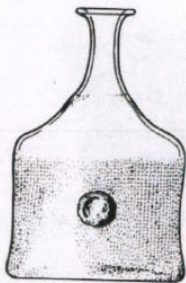

48011-3
Vas oval Miniatur 1/kart.
Vase oval Miniature 1/box
H: 75 mm/3"



48012-3
Flaska Miniatur 1/kart.
Bottle Miniature 1/box
H: 105 mm/4 1/8"



58012-3
Miniatur
Miniature
Skål 1/kart.
Bowl 1/box
H: 55 mm/2 1/8"
Ø: 70 mm/2 3/4"



Boda Artist Collection Boda Ocean

Design:
Ulrica
Hydman-Vallien



97919-3
Pokal
Goblet
H: 165 mm/6 1/2"



97920-3
Pokal
Goblet
H: 210 mm/8 1/4"



97921-3
Pokal
Goblet
H: 245 mm/9 5/8"



87919-3
Kanna
Jug
H: 240 mm/9 1/2"



77919-3
Fat
Dish
Ø: 270 mm/10 5/8"

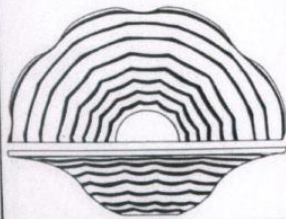

78012-3
Miniatyr
Miniature
Fat 1/kart.
Dish 1/box
Ø: 85 mm/3 3/8"



88012-3
Miniatyr
Miniature
Kanna 1/kart.
Jug 1/box
H: 80 mm/3 1/8"









98012-3
Miniatyr
Miniature
Pokal 1/kart.
Goblet 1/box
H: 90 mm/3 1/2"

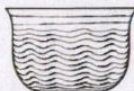

Boda Artist Collection

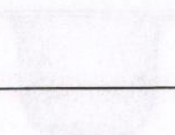
Boda Ocean

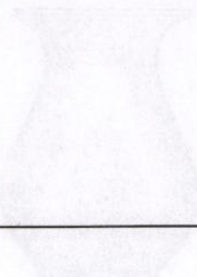
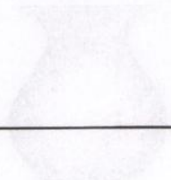
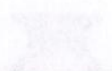
Design:
Ulrica Hydman-Vallien

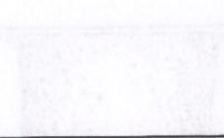
<p>58139-3 Skål grön Bowl green Ø: 170 mm/6 5/8"</p> 	<p>58140-3 Skål blå Bowl blue Ø: 220 mm/8 5/8"</p> 	<p>78139-3 Fat blå Dish blue Ø: 360 mm/14 1/8"</p> 	
			
			

Design:
Ulrica
Hydman-Vallien

Boda Artist Collection Boda Pastell



47867-3
Vas
Vase
H: 120 mm/4 3/4"



47868-3
Vas
Vase
H: 200 mm/7 7/8"

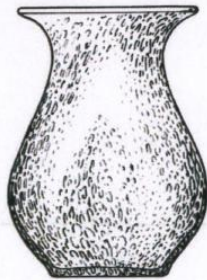

57867-3
Skål
Bowl
Ø: 145 mm/5 3/4"

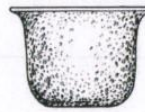

57868-3
Skål
Bowl
Ø: 180 mm/7 1/8"

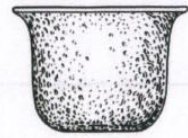

57869-3
Skål
Bowl
Ø: 240 mm/9 1/2"



77867-3
Fat
Dish
Ø: 275 mm/10 7/8"

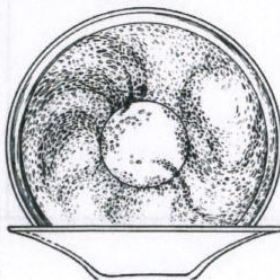

87867-3
Kanna 150 cl
Jug 7 oz
H: 200 mm/7 7/8"











48013-3
Miniatur
Miniature
Vas 1/kart.
Vase 1/box
H: 55 mm/2 1/8"



Boda Artist Collection

Boda Pastell

Design:
Ulrica
Hydman-Vallien

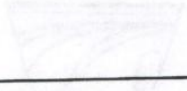
<p>58013-3 Miniatur Miniature Skål 1/kart. Bowl 1/box H: 50 mm/2" Ø: 65 mm/2 1/2"</p> 	<p>78013-3 Miniatur Miniature Fat 1/kart. Dish 1/box Ø: 90 mm/3 1/2"</p> 	<p>88013-3 Miniatur Miniature Kanna 1/kart. Jug 1/box H: 55 mm/2 1/8"</p> 	
			
			

Boda Artist Collection

Boda Pearl

Design:
Bertil Vallien



48045-3
Vas
Vase
H: 130 mm/5 1/8"



48046-3
Vas
Vase
H: 210 mm/8 1/4"



48047-3
Vas
Vase
H: 260 mm/10 1/4"

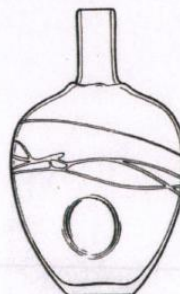

58045-3
Skål
Bowl
H: 80 mm/3 1/8"
Ø: 110 mm/4 3/8"

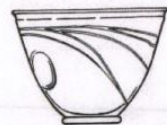

58046-3
Skål
Bowl
H: 110 mm/4 3/8"
Ø: 150 mm/5 7/8"

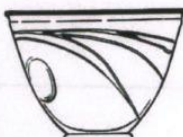

58048-3
Skål på fot
Bowl footed
H: 140 mm/5 1/2"
Ø: 150 mm/5 7/8"



68045-3
Ljustake
Candlestick
H: 200 mm/7 7/8"

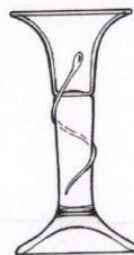

Boda Artist Collection

Boda Volcano

Design:
Bertil Vallien

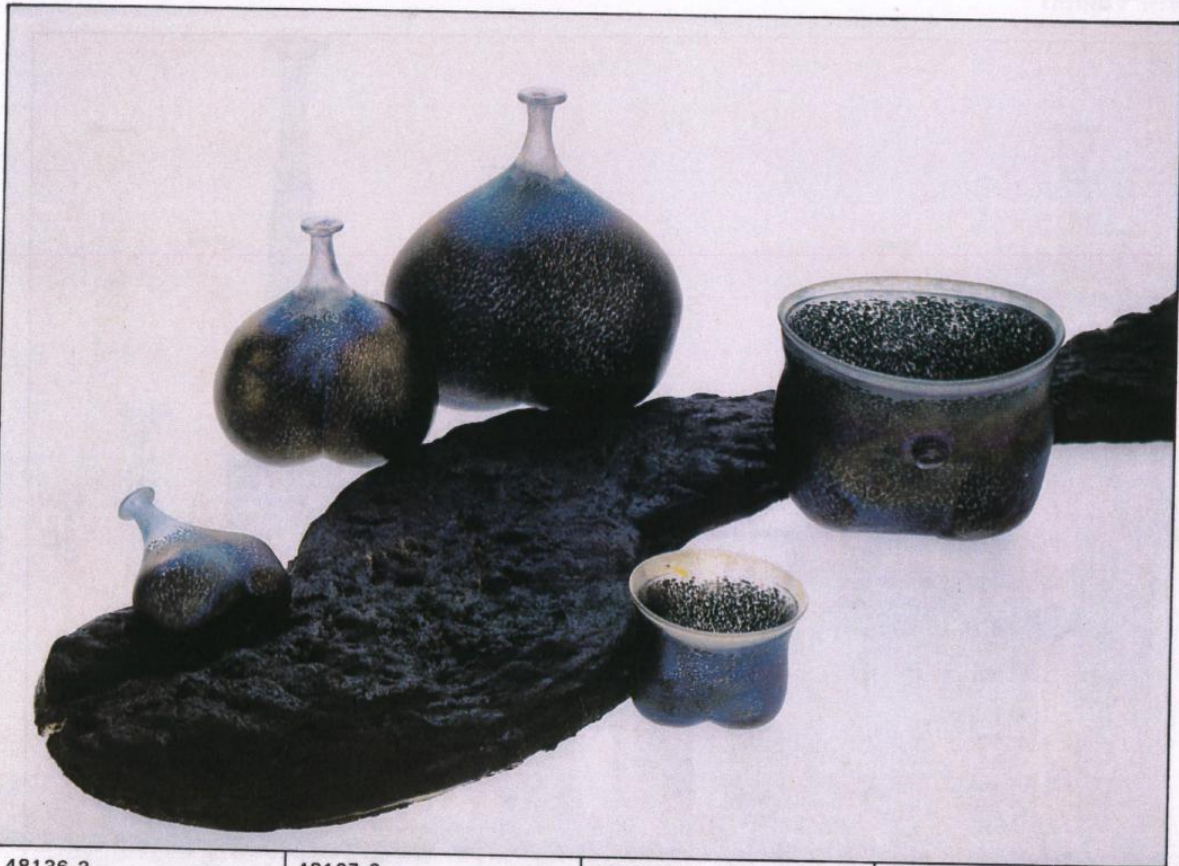

48136-3
Vas
Vase
H: 110 mm/4 3/8"



48137-3
Vas
Vase
H: 160 mm/6 1/4"



48138-3
Vas
Vase
H: 200 mm/7 7/8"

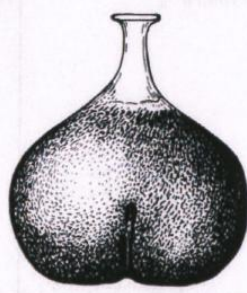

58136-3
Skål
Bowl
H: 85 mm/3 3/8"
Ø: 120 mm/4 3/4"

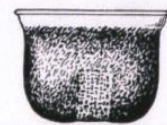

58137-3
Skål
Bowl
H: 130 mm/5 1/8"
Ø: 170 mm/6 5/8"

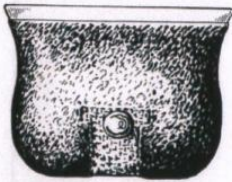

Boda Artist Collection Boda Wind Pipes

Design:
Bertil Vallien



48173-3
Vas
Vase
H: 180 mm/7 1/8"



48174-3
Vas
Vase
H: 240 mm/9 1/2"



48175-3
Vas
Vase
H: 330 mm/13"



48176-3
Vas
Vase
H: 200 mm/7 7/8"



48177-3
Vas
Vase
H: 390 mm/15"

